



X-ray Optics: past, present, and future

Paul B. Reid

Harvard-Smithsonian Center for Astrophysics

Six Year of Science with Chandra Symposium

Cambridge, MA

November 2, 2005

Introduction

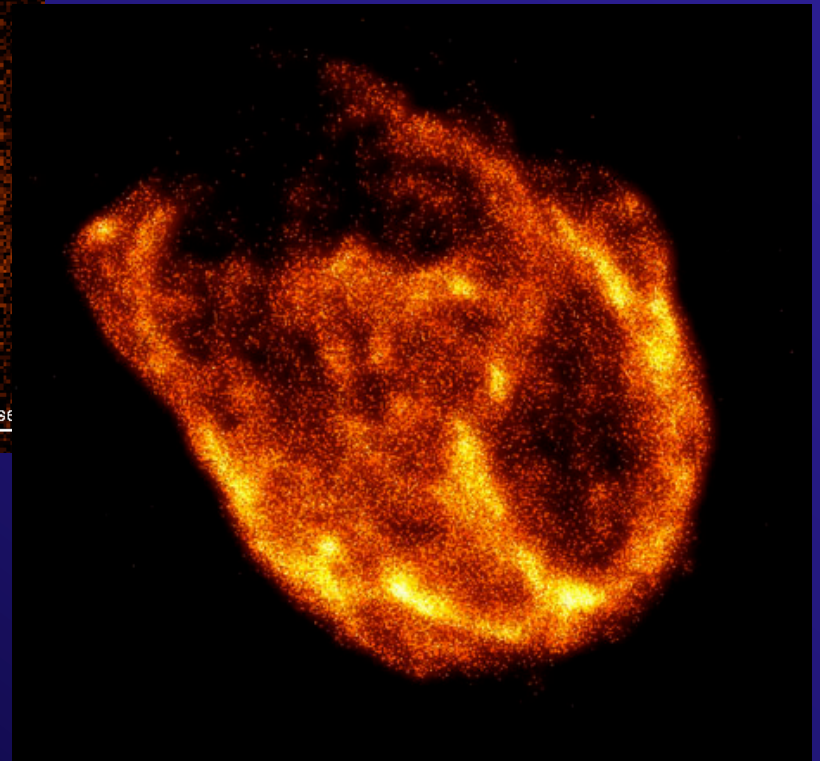
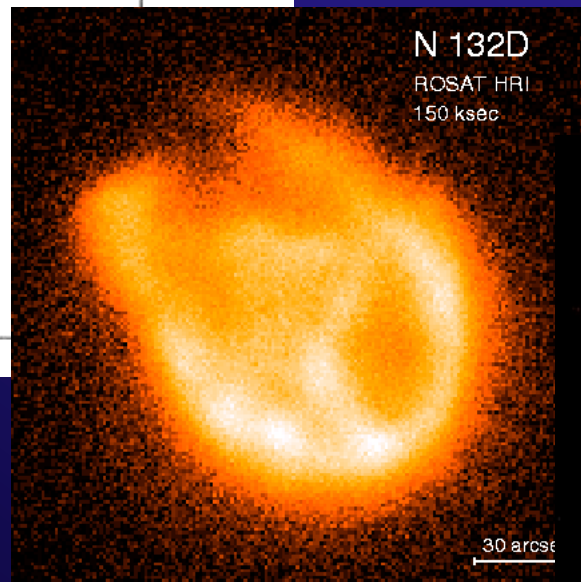
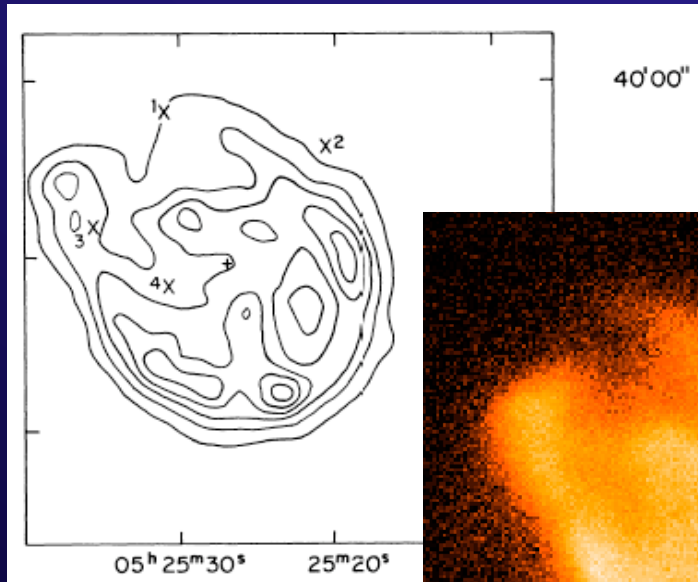

In the beginning...

- **Roentgen (1895): x-rays could not be concentrated by lenses**
- **Compton (1923) demonstrated the E-M nature of x-rays by reflecting them from polished metal surfaces at grazing incidence.**
 - concluded index of refraction < 1 leading to *total external reflection*
- **Development driven by the goal of x-ray microscopy, which offered higher resolution than optical microscopy**
- **Jentsch (1929) extensively studied imaging at grazing incidence**
 - could not form good images with a single spherical mirror
 - too much astigmatism
 - single toroidal or cylindrical mirror with different radii of curvature
 - two reflection systems

First images: Kirkpatrick and Baez

- **Kirkpatrick and Baez (1948) developed the first practical system for x-ray imaging - crossed parabolas or ellipses of translation**
 - obtained first x-ray images (of a mesh screen)

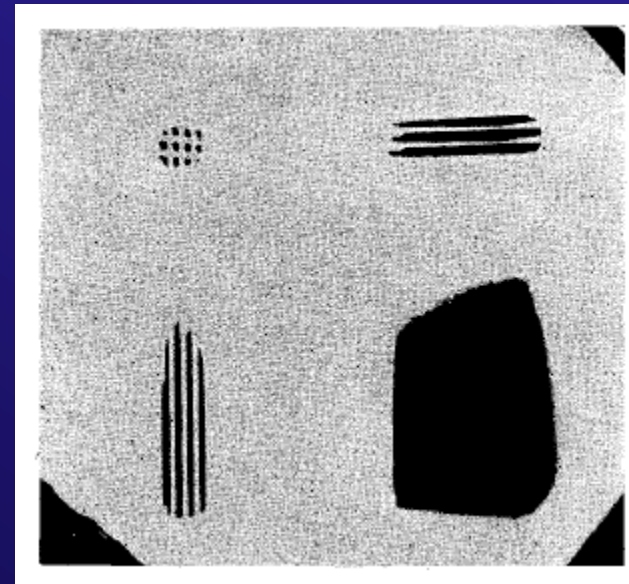
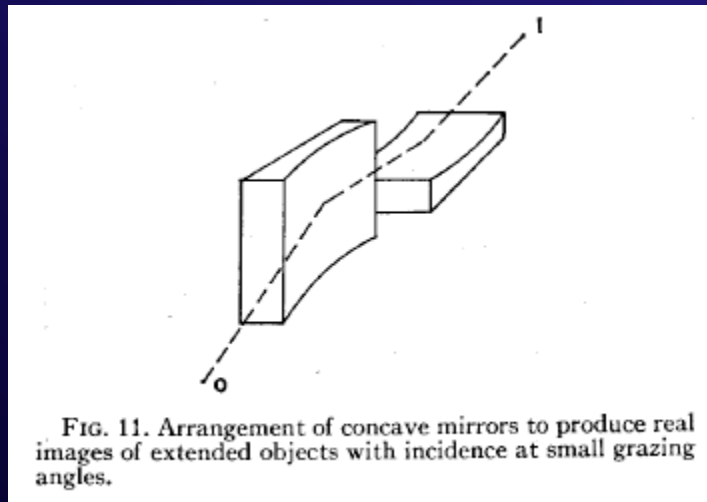

figures from Kirkpatrick, P., and Baez, A.V., "Formation of optical images by x-rays," *JOSA* **38**, No. 9, 766 (1948).

Cylindrical Optics: Wolter

- **The K-B optics initially had a limited aperture, albeit they were envisioned as being reasonably “easy” to fabricate.**
- **But K-B optics do not meet the classical optical imaging Abbe Sine condition**
 - Abbe Sine condition: the intersection of the incoming rays and the focused rays all need to lie on a common spherical surface whose center lies at the focus
 - satisfaction of the Sine condition necessary to achieve imaging over reasonable fields-of-view with minimal aberration
- **Wolter (1952) developed a set of near cylindrical telescopes that nearly meet the Sine condition**

The Wolter Telescopes

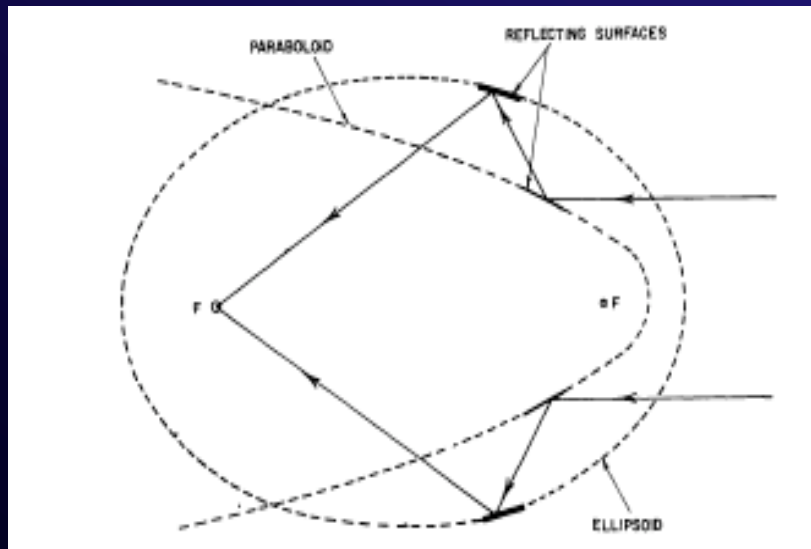
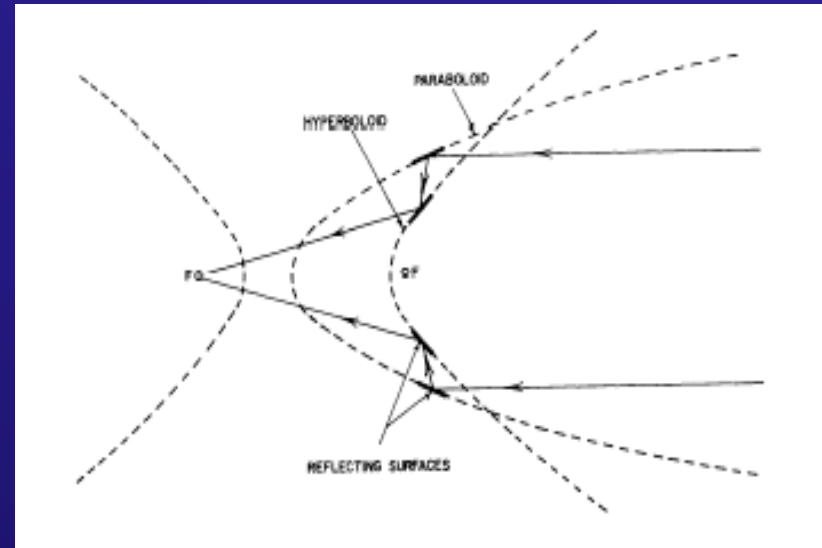
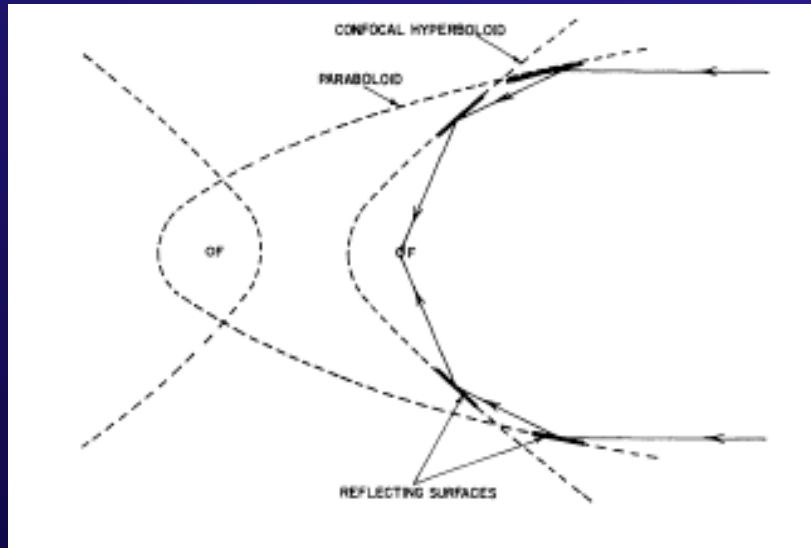

Figures from Giacconi, Reidy, Vaiana, Van Speybroeck, and Zehnpfennig, "Grazing Incidence Telescopes for X-ray Astronomy," *Sp. Sci. Rev.* **9**, 3 (1969), after Wolter, H., *Ann. Physik* **10**, 94 (1952) and Wolter, H., *Ann. Physik* **10**, 286 (1952).

X-ray Telescopes

- In 1960 Ricardo Giacconi and Bruno Rossi first suggested that x-ray imaging optics be used for space based x-ray telescopes for solar and cosmic x-rays
- Giacconi and Rossi also the first to suggest nesting a set of confocal telescopes to substantially increase the collecting area of the telescope

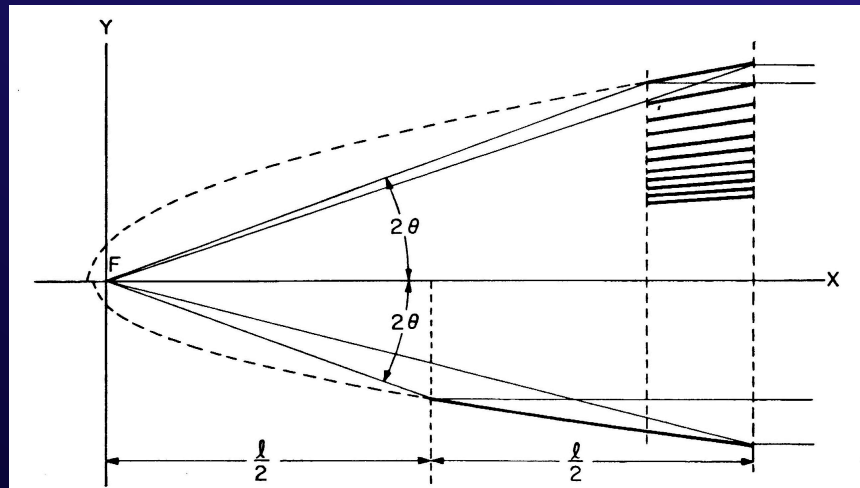

figure from Giacconi, R., and Rossi, B., "A telescope for soft x-ray astronomy," J. Geophys. Res., **65**, 773 (1960).

Early GI telescope image of the Sun

- Suggestion of Giacconi and Rossi led to the development of the first astronomical telescope and sounding rocket observations of the solar corona in March of 1965

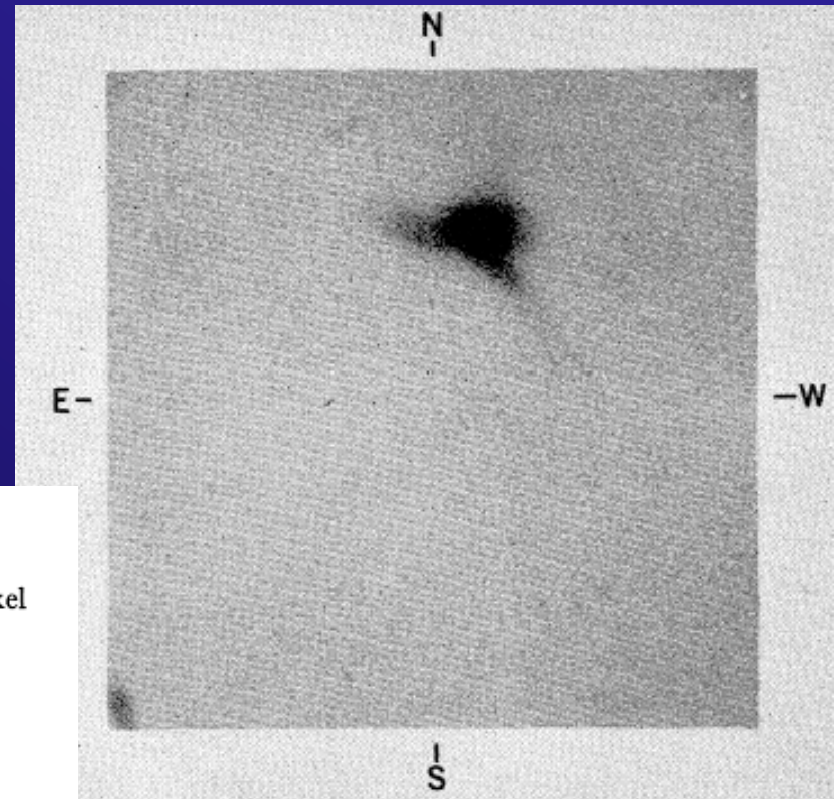

TABLE 1

TELESCOPE CHARACTERISTICS

Mirror material	. Electroformed nickel
Diameter of mirror	. 7.6 cm
Focal length	. 83.6 cm
Collecting area	. 1.6 cm ²
Slope of first surface	. 40'
Slope of second surface	. 120'
Diameter of solar image	. 0.75 cm
Telescope efficiency, paraxial rays, measured at 8 Å	. 15 per cent

table and figure from Giacconi, Reidy, Zehnpfennig, Lindsay, and Muney, "Solar X-ray Images Obtained Using Grazing Incidence Optics," *Ap. J.* **142**, 1274 (1965)

Einstein, ROSAT, and Chandra

N132D - brightest SNR in LMC

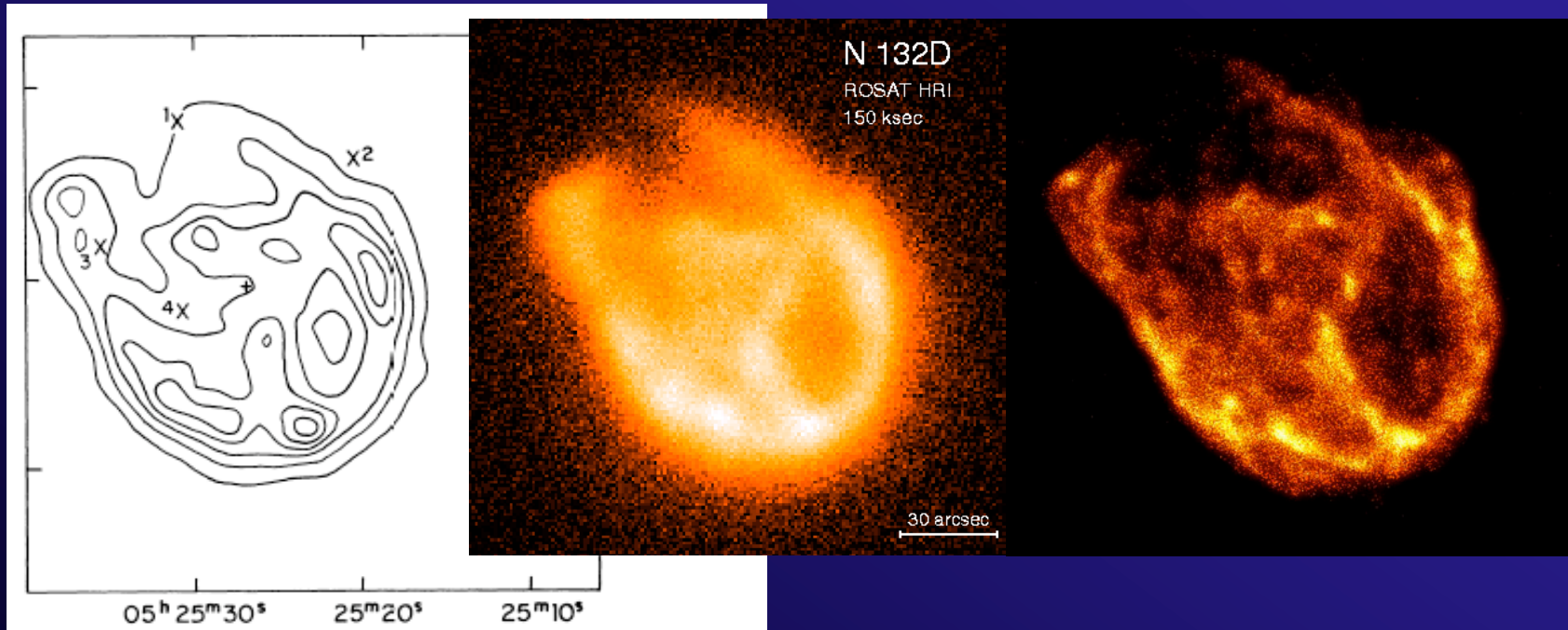

Einstein, ROSAT, and Chandra

Crab Nebula

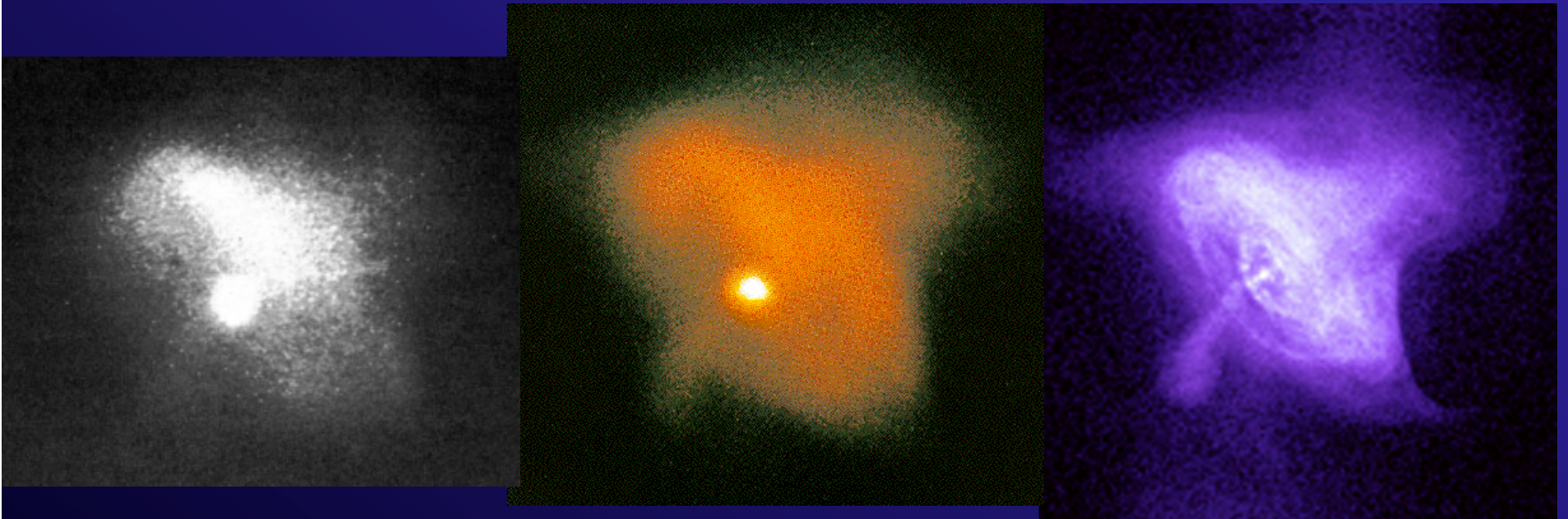

Einstein, ROSAT, and Chandra

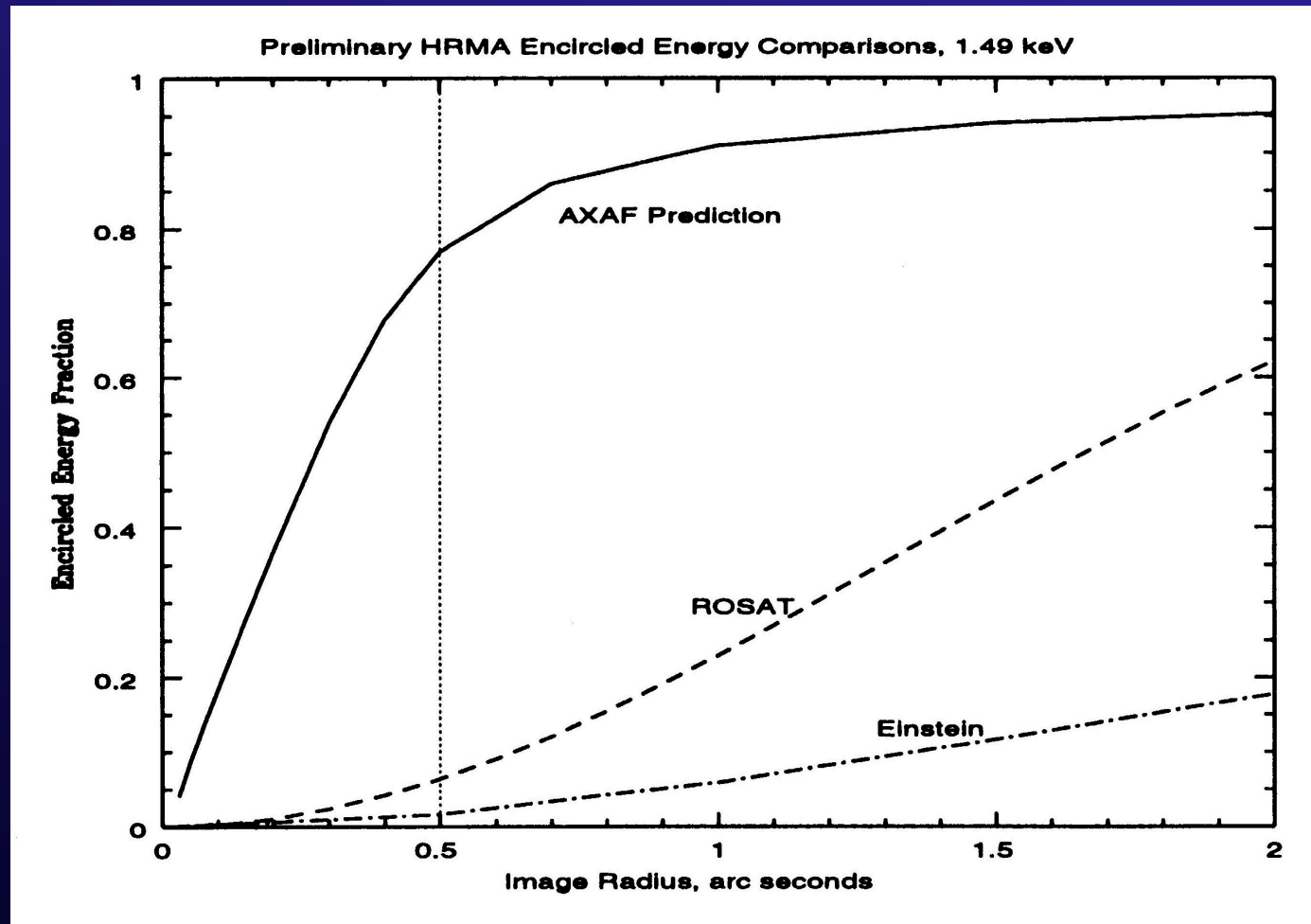

Einstein, ROSAT, and Chandra

- **In the early 70's, while the first solar grazing incidence x-ray telescopes were being built, Leon van Speybroeck, along with Chase and Zehnpfennig undertook the first systematic examinations of both K-B and Wolter-I grazing incidence optics**
 - examined limiting performance
 - off-axis performance
 - developed ray tracing models
 - optic error sensitivities
- **All these used to estimate EINSTEIN optics requirements**

Einstein, ROSAT, and Chandra

- **First, how were Einstein (and ROSAT) built?**
- **Start with a cylindrical optic**
 - Grind the general shape (cone, radii)
- **Measure figure error**
 - measure the radial runout - circularity profiles
 - measure axial figure
 - piece together the optic surface like a barrel from its staves and rings
 - reasonable since out-of-plane scatter reduced by a factor of $\sin \alpha \leq 1/60$

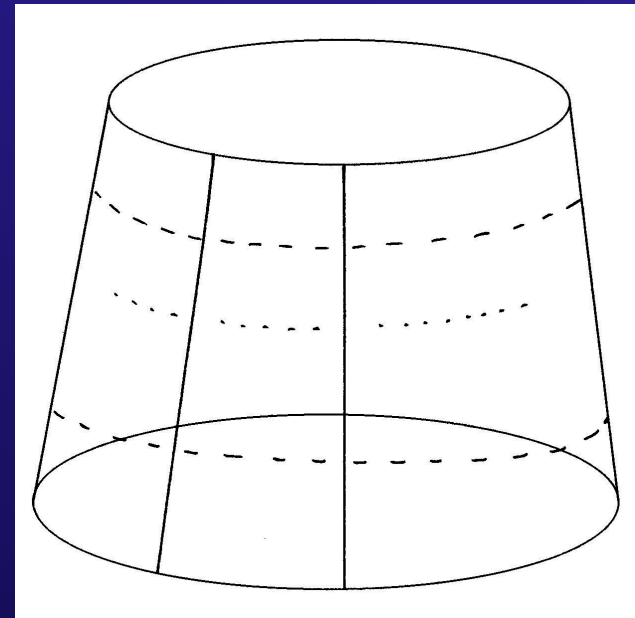

Einstein, ROSAT, and Chandra

- For Einstein, Leon van Speybroeck recognized deformation of optics under the influence of gravity (self-weight deflection, SWD) could be significant. Some metrology - roundness - needed to be performed with optic axis vertical, but optic still distorts significantly.

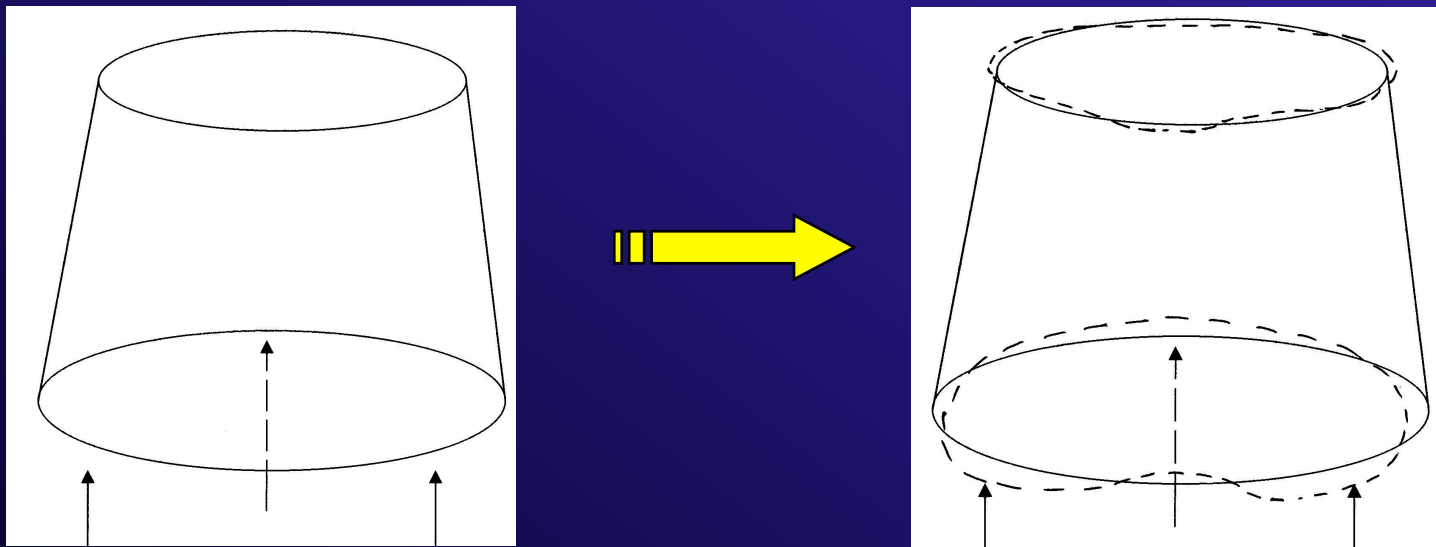

Einstein, ROSAT, and Chandra

- **SWD produces large deformations at the support end, smaller out of phase deformations at the “free” end**
 - for Einstein, out-of-phase radial runout ($\Delta\Delta r$) < 1.27 μm
- **Leon recognized the criticality of SWD and so**
 - devised the liquid mercury metrology mount
 - float the mirror (on its end) on a pool of mercury
 - after floated, raise 3 support pads to just make contact with the optic and stabilize it with minimum deformation

Einstein, ROSAT, and Chandra

- **For Chandra, radial errors due to SWD much larger than Einstein (significantly heavier optic with similar wall thickness)**
- **Hg pool > 1 m diameter became a poor idea**
- **Hughes Danbury Optical Systems (HDOS, now Goodrich, formerly Perkin-Elmer) developed a complicated mount with 12 - 18 mechanical off-loaders (depending upon optic size)**
 - 3 “hard” points with load cells
 - 9 to 15 soft points with jewel bearings
 - took several hours to set up the optic on the met mount
- **SWD ~ 0.15 um P/V (significant relative to the requirement)**
- **Required a correction of data**
 - experimentally verified the distortion
 - data had SWD subtracted
- **Feature of met mount - measure the optic wide end down, or narrow end down.**

Einstein, ROSAT, and Chandra

♣ Polish figure with large laps of various sizes on “Roller Polisher”

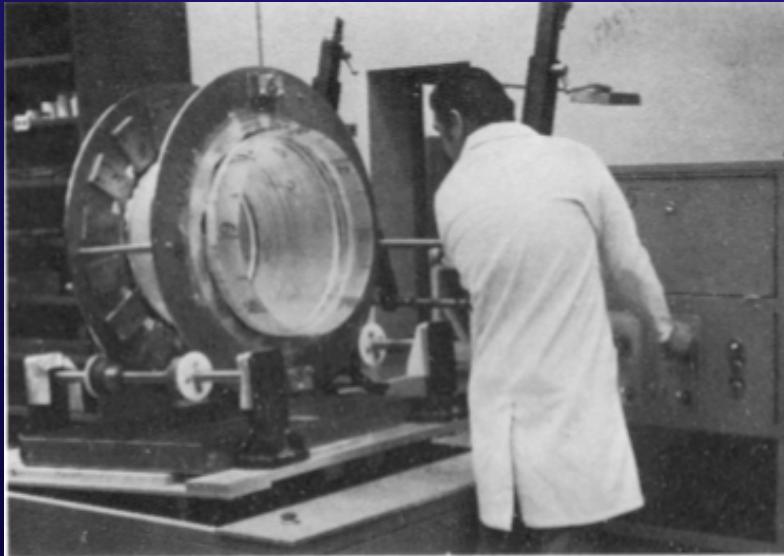

Einstein roller polisher at Perkin-Elmer Corp
(now Goodrich Aerospace)

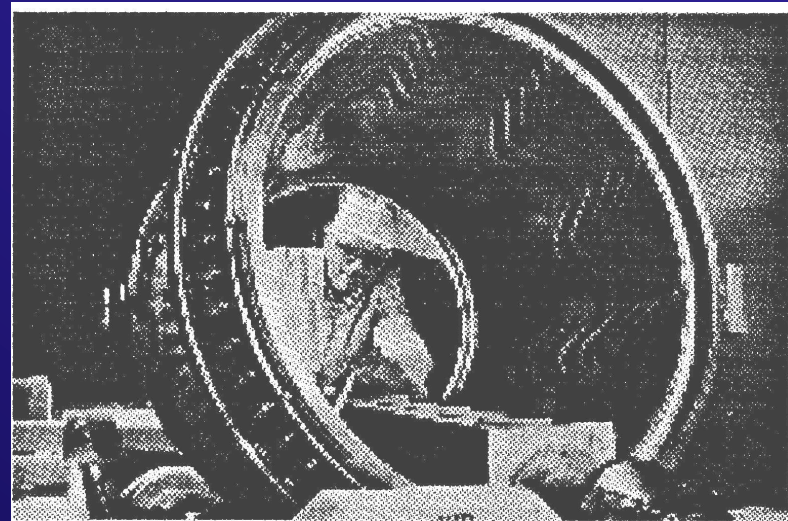

ROSAT roller polisher at Zeiss

♣ Iterate by re-measuring, polishing, etc.

Einstein, ROSAT, and Chandra

- **Fabrication - iterative polish/metrology was slow on Einstein**

$$\frac{\Delta \text{figure_error}}{\text{figure_error}} \approx 0.1$$

so 2.5 um to 0.04 um requires ~ 39 iterations (cycles)

- **Gradually, optics manufacturers such as Perkin-Elmer developed computer controlled polishing**
 - small tool whose removal rate was varied locally by computer
 - better figure control than large laps on roller polisher
 - less dependent upon the glass support for polishing



Einstein, ROSAT, and Chandra

- **Leon van Speybroeck, during the Chandra (then AXAF) pathfinder program TMA, suggested mathematically optimizing the set of computer commands to more efficiently computer control polish**
 - during TMA, improved the figure correction rate from 10 per cent (Einstein) to ~ 35 per cent
- **Polishing Chandra incorporated additional improvements**
 - math model of optimized computer controlled polishing developed in Danbury and used to guide the polishing process
 - error correction rates of 80 to 95 per cent
 - last optics corrected from ~ 1.5 μm RMS to 40 Angstroms RMS in 3 iterations
 - employing the model, would polish for several hundred hours between measurements and get the predicted results

Replication: Thermal forming

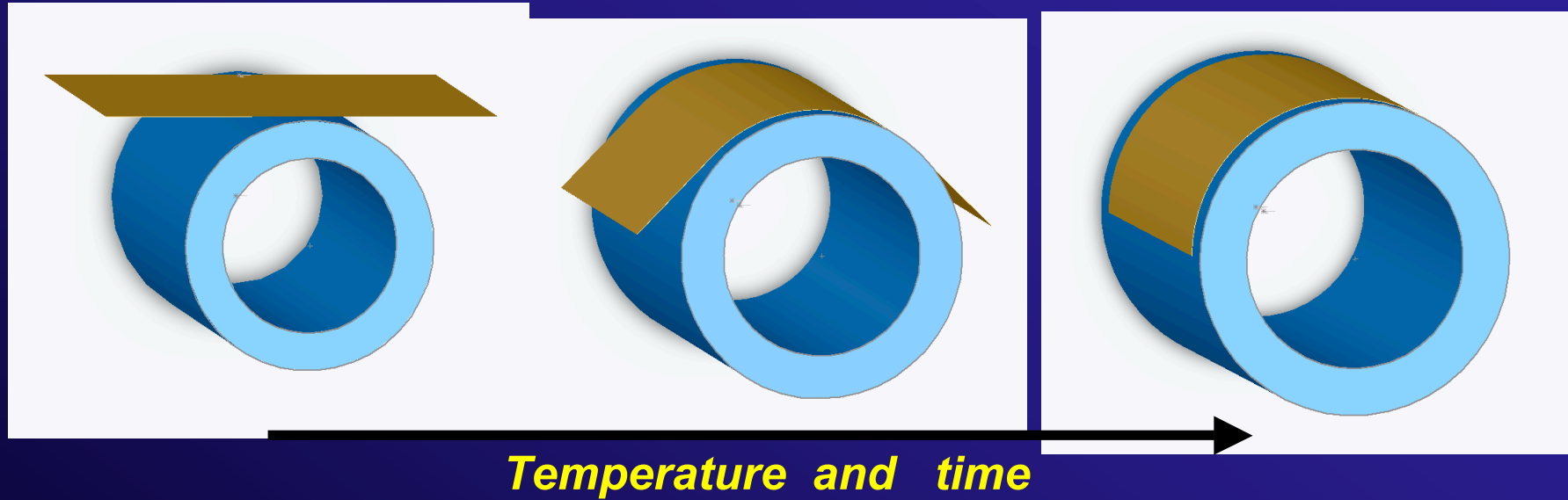

- **Thermal forming (slumping):** at high temperature glass flows more readily and takes on the shape of the forming mandrel. Gravity or other means may be used to assist.
- **Important Factors**
 - Mandrel material/surface treatment prevents sticking and friction.
 - Temperature uniformity on the glass sheet is essential. Temperature gradients produce thermal stresses that result in figure error post-slumping.

Figure from W. Zhang, NASA Goddard Space Flight Center

Replicated Optics - Constellation-X

- **Thermally form segments of paraboloid and hyperboloid**
 - very thin glass - ~ 0.2 to 0.6 mm thick
 - temperatures of $\sim 600 - 650$ C
- **After slumping, epoxy replicate**
 - apply thin layer (5 - 25 μm) of epoxy to slumped substrate
 - place epoxy coated substrate in contact with precision replication mandrel with Au coating.
 - Cure epoxy
 - Upon removal of reflector from mandrel, Au coating sticks to epoxy and is transferred to reflector.

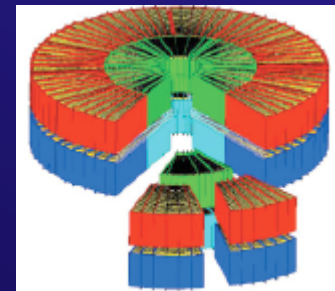
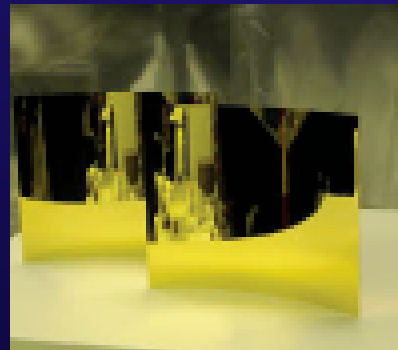

Replicated Optics - Constellation-X

- **Con-X: 4 telescopes each with $\sim 0.5 \text{ m}^2$ area (1 keV), ~ 15 arc-sec (HPD) resolution, and high resolution spectroscopy**
- **Advantages of replicated optics**
 - low cost/area
 - well suited for multiple copies
 - Con-X - 24 or 48 copies of each reflector
 - large area/weight
 - Con-X $\sim 22 \text{ cm}^2/\text{kg}$; Chandra $\sim 0.5 \text{ cm}^2/\text{kg}$
- **Disadvantages of replicated optics**
 - limited performance
 - Con-X goals = 5 arc-sec HPD
 - segmented, and extremely flimsy - complicates metrology, assembly, and alignment

Silicon Pore Optics - XEUS?

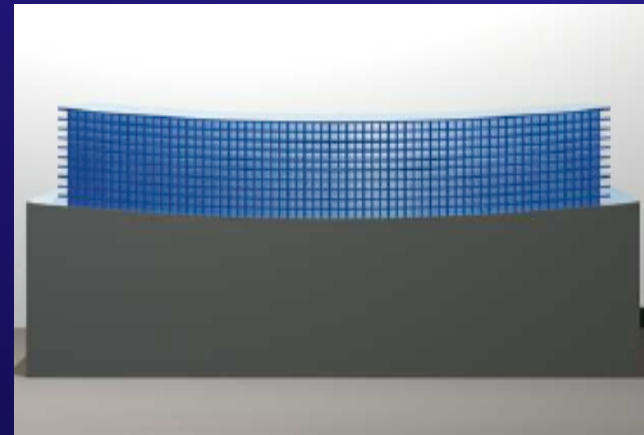
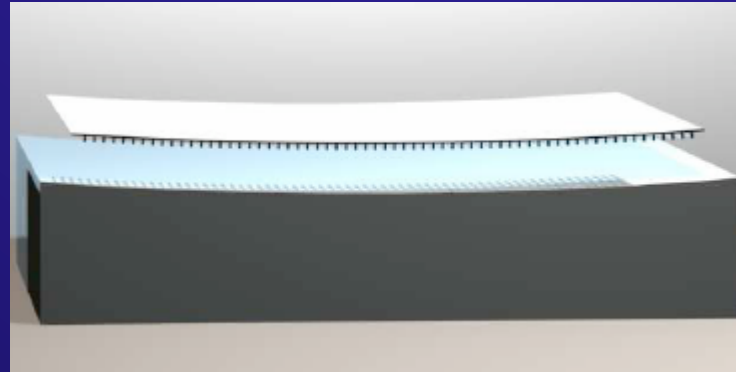
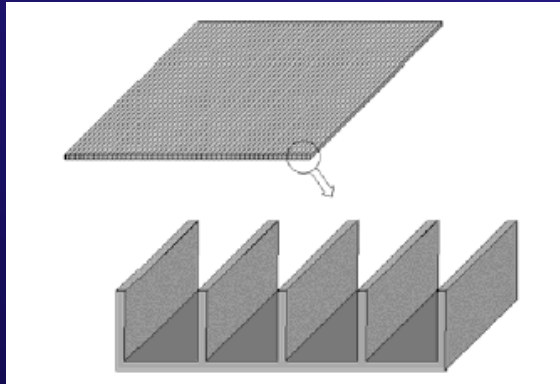

■ Conical, not Wolter I

- approximation to a Wolter I adds aberration to image

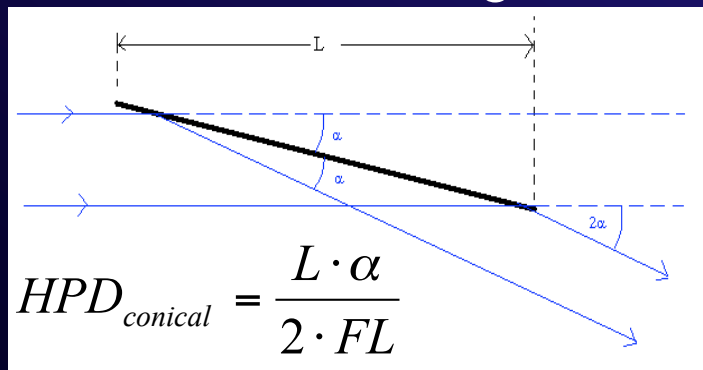

top left figure from Bavdaz, *et. al.*, SPIE Proc. **5488** (2005)

right hand figures from Beijersbergen, *et. al.*, SPIE Proc. **5488** (2005)

Silicon Pore Optics - XEUS?

■ Advantages

- high strength to weight
- don't have to manufacture optical surface
 - rely upon a 10^2 G\$/yr semiconductor industry to drive wafer performance

■ Disadvantages

- performance limitation of conical approximation
 - long focal length + short reflectors, or
 - large conical approximation contribution to imaging
- vignetting in primary/secondary alignment
- distortion limitations to figure (?)

Beyond Chandra

- **Desire larger collecting area than Con-X - $10^1 - 10^2 \text{ m}^2$**
- **Want 10 to 100 times better imaging**
- **Implies grazing incidence optics with**
 - 3 to 10 times better figure than Chandra
 - more densely nested, thinner, shells
 - shells need to be much lighter - outermost Chandra shell $\sim 400 \text{ kg}$
- **But**

$$SWD \propto \frac{\text{Weight}}{t^3}, \quad \text{and } \text{Weight} \propto t, \text{ so } SWD \propto \frac{1}{t^2}$$

- 1 mm thick wall vs. 10 - 25 mm thick \rightarrow 100 times the SWD - impractical to correct to factors of 3 to 10 better than Chandra
- **Need a different solution**

Beyond Chandra

- **Gen-X**

(1) too many shells to figure individually

(2) figure requirements significantly tighter than Chandra, much tighter than slumped or replicated optics



Leads us to Adjustable Grazing Incidence Optics

Adjustable bi-morph mirror

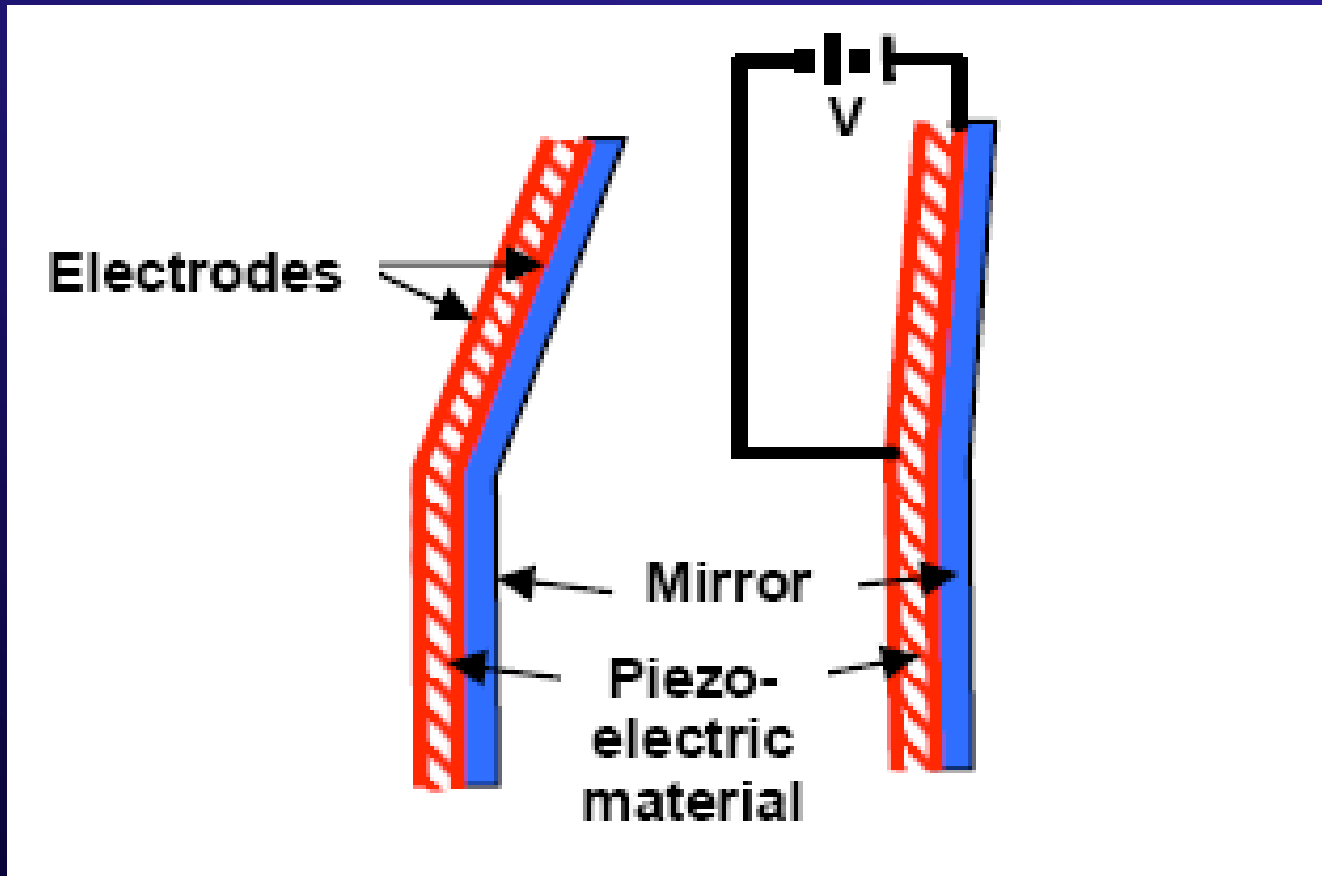

Under applied voltage V , the piezo material imparts a force to the mirror, bending it

Adjustable stack mirror

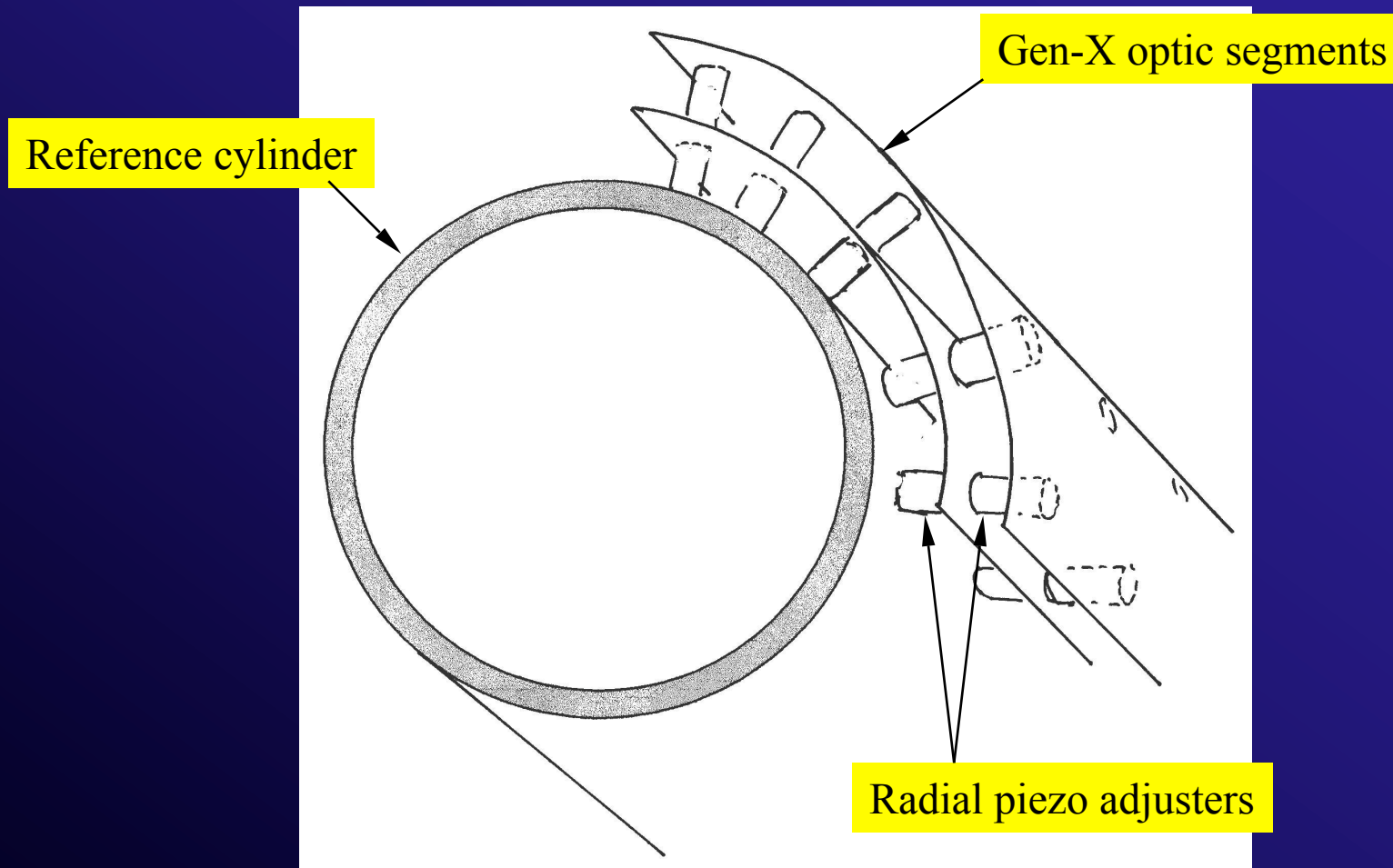

Adjustable Optics - Requirements

Parameter	Con-X	Gen-X	Resolution (HPD, arc-sec)	15 (required)	5 (goal)	0.1	Mirror Effective A

- **Requirements are extremely challenging, but follow along continuing development of x-ray telescope capabilities**
- **To achieve requirements we consider four alternative designs of grazing incidence systems:**
 - 8 m diameter 50 m focal length - set of four telescopes
 - 20 m diameter - single telescope
 - 75 m 125 m, and 150 m focal lengths

Mirror Axial Figure Error Requirements

Because of the use of adjustable optics, the as-fabricated mirror figure can be substantially poorer than the as-adjusted final figure. The post adjustment figure PSD shown on the right (red) is based upon an assumed frequency dependent adjustment filtering of the allocated manufacturing error (black). Also shown for comparison purposes are the Chandra PSD and Con-X goals.

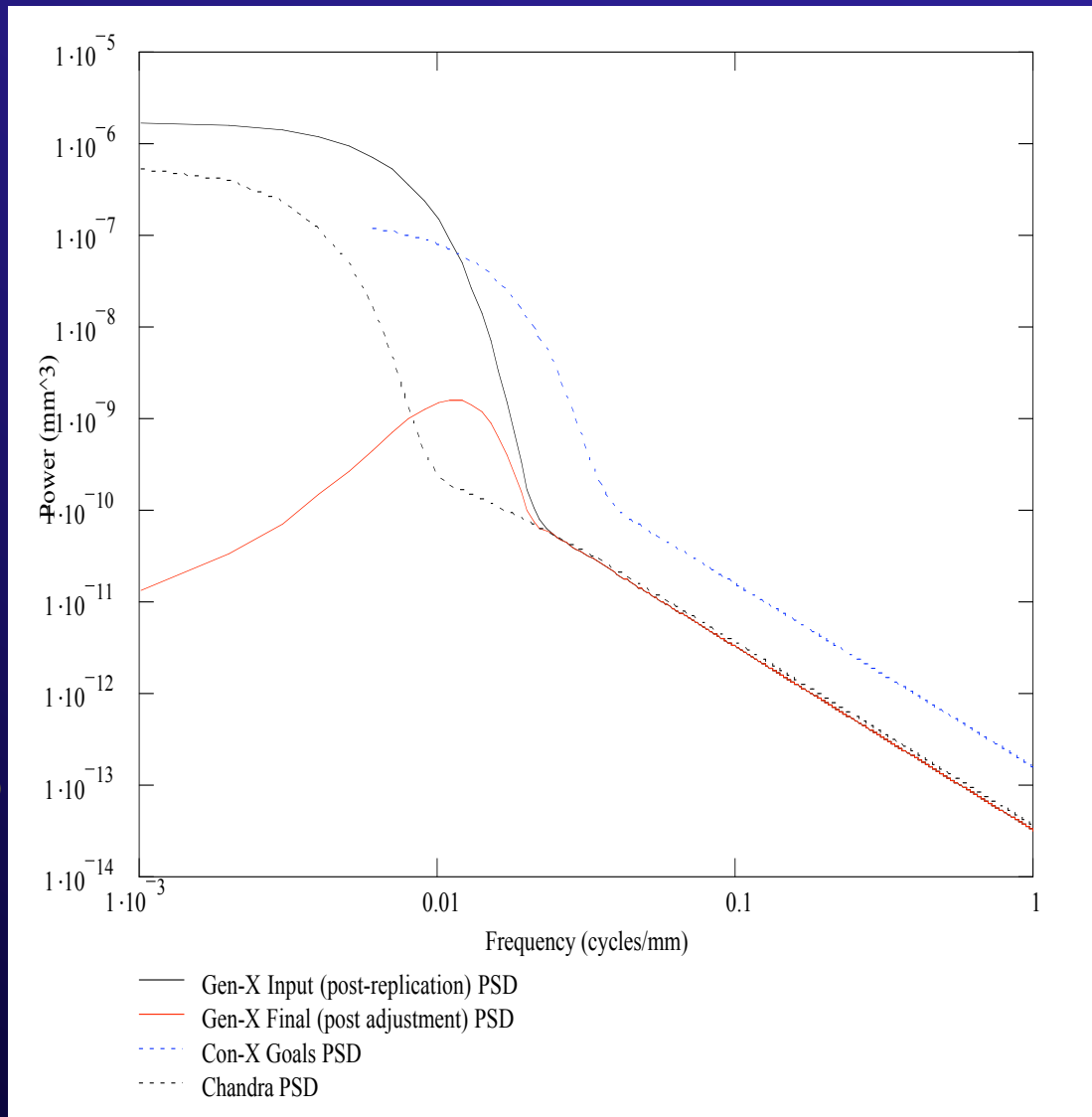

Encircled Energy

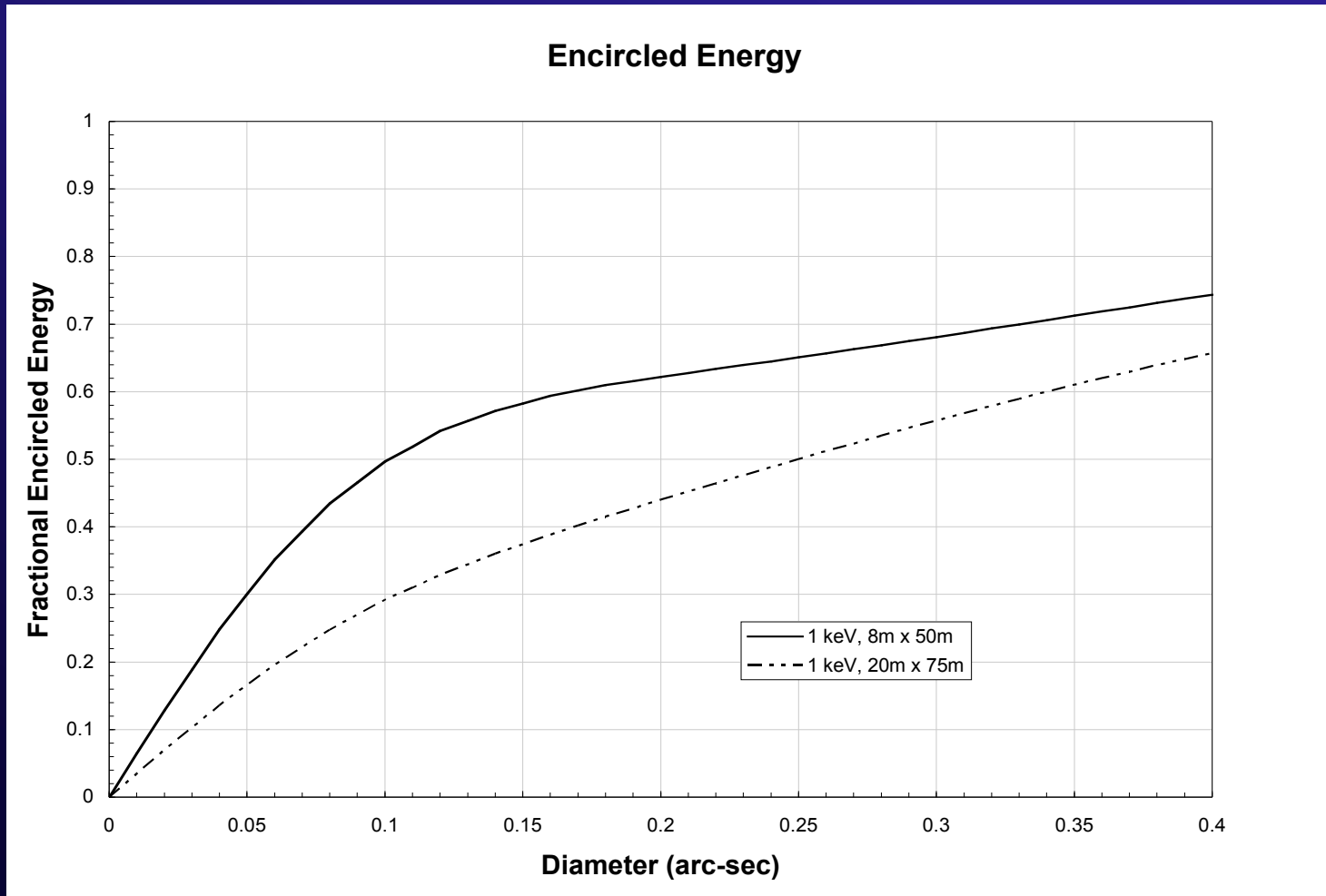

Telescope design has significant impact upon performance
Shallower graze angle designs yield better performance

Diffraction-Refractive Optics

- Refractive lenses for x-rays were first dismissed as impractical by Roentgen, and then later by Kirkpatrick and Baez
- Later, researchers started using Zone Plates for x-ray microscopy (Kirz, 1974)
- In mid '90's, Dewey et. al. described a diffractive x-ray telescope
- Further work by Gorenstein, Skinner, and van Speybroeck
- **Diffraction Optics - Fresnel Zone Plates**

Zone plate focal length $\propto 1/\lambda$
Large amount of chromatic aberration
- small energy bandwidth

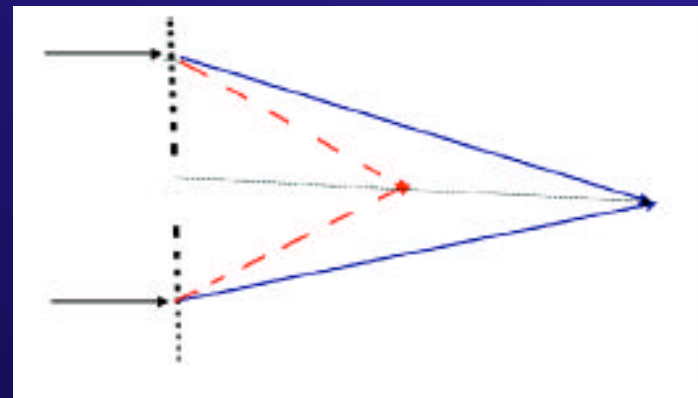

Diffractive-Refractive Optics

- **Refractive lenses**

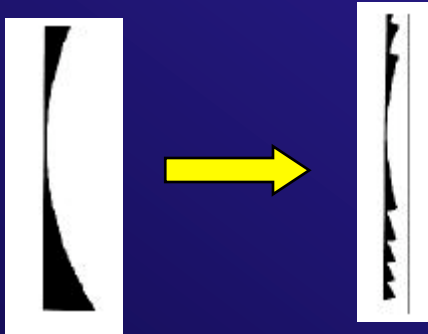

$R = 2F\delta$, to minimize lens thickness and absorption, use Fresnel lens

Here $FL \propto 1/\lambda^2$

- **Leon van Speybroeck came upon the idea of combining diffractive and refractive elements, of opposite power, and optimizing to minimize the chromatic aberration**

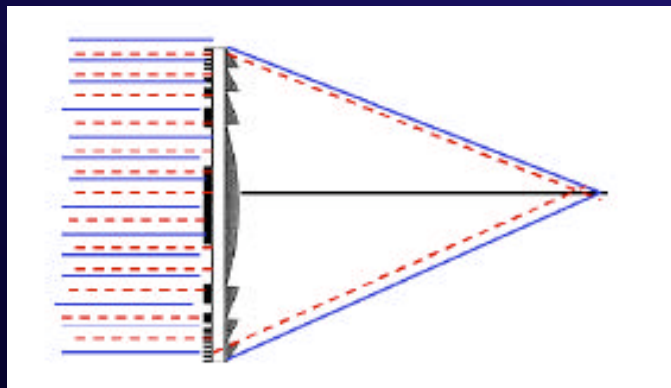

Optimizing design can achieve bandwidths $\Delta E/E$ of ~ 5 per cent, approximately doubles the focal length over the Fresnel lens case

Resolution $\theta_{\Delta E} = 0.2(\Delta E/E)(d/f) \sim 10 \mu\text{-arc-sec}$

Key points - focal lengths very long - 10^2 to 10^6 km.
Focal planes very large -

$10 \mu\text{-arc-sec @ } 10^6 \text{ km} \sim 50 \text{ mm}$

Summary

- **“The future [of x-ray optics] is bright”**
- **Many technical options exist, offering higher resolution and higher collecting area than Chandra**
- **Plenty of technical areas to delve into**
 - probably more than there is funding

Dedication

**This talk is dedicated to the
memory of
Leon van Speybroeck,
without whom neither would I
be here talking to you nor
would Chandra be the
exquisite Observatory it is.**

