



Modeling Pile-up

John E. Davis

<davis@space.mit.edu>



Outline

- Event Detection
- Grade Migration
- The “Standard Model”
- The Pile-up Model
- Data Preparation
- Using the model in `sherpa` and `isis`
- Examples



When a photon is absorbed in the silicon of a CCD, a charge cloud of electron-hole pairs is formed (≈ 3.65 eV per pair).

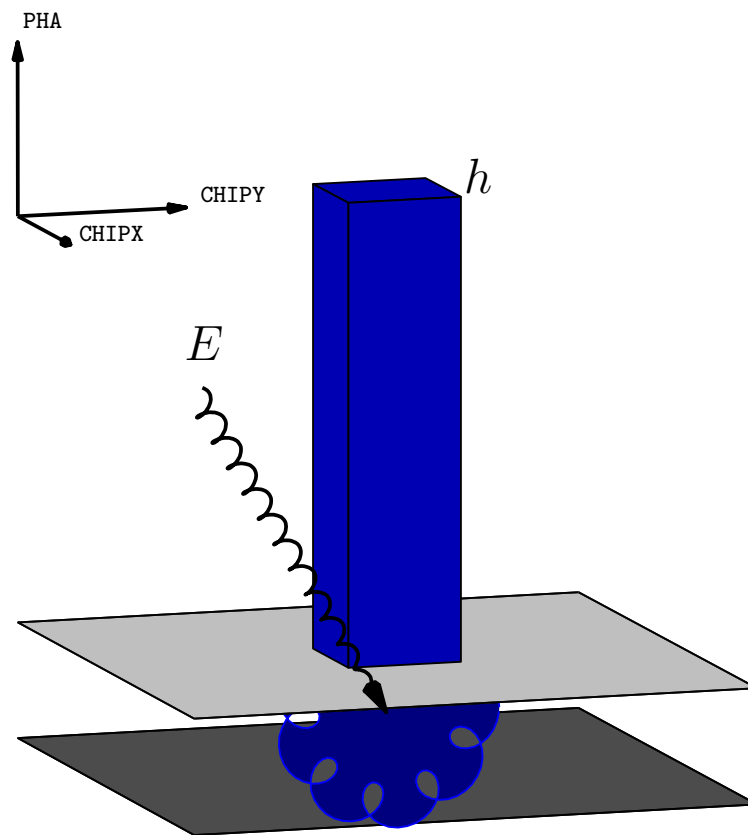

The pulse-height is a measure of the number of pairs in the cloud.



For a bright source, there is a non-negligible probability for two or more photons to arrive in the same region during an integration time. The detector will be unable to distinguish the two events. This phenomena is called “pile-up”.

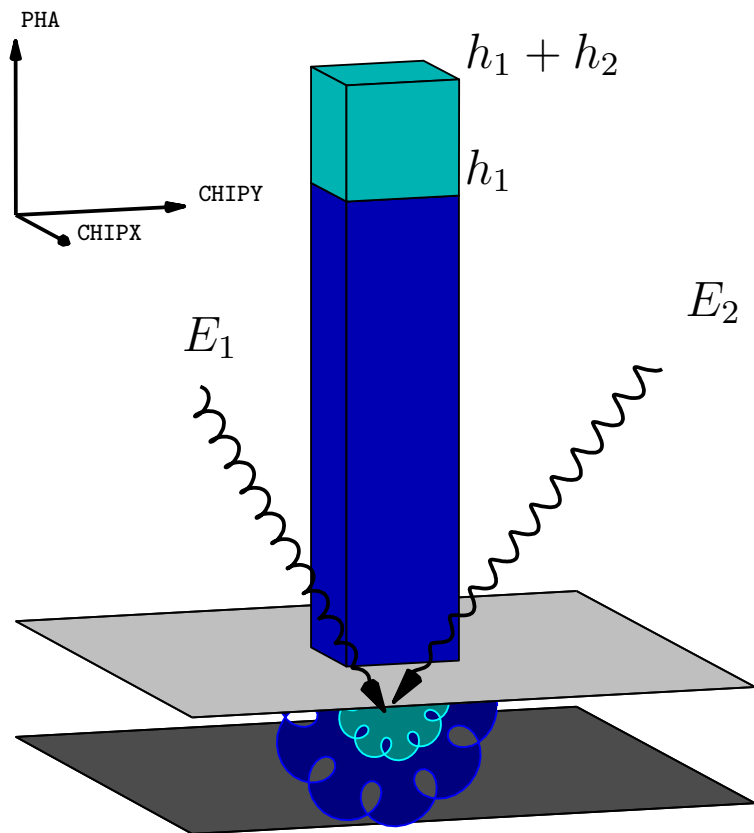



Pile-up manifests itself by a lower event detection rate and an energy spectrum distorted towards higher energies.

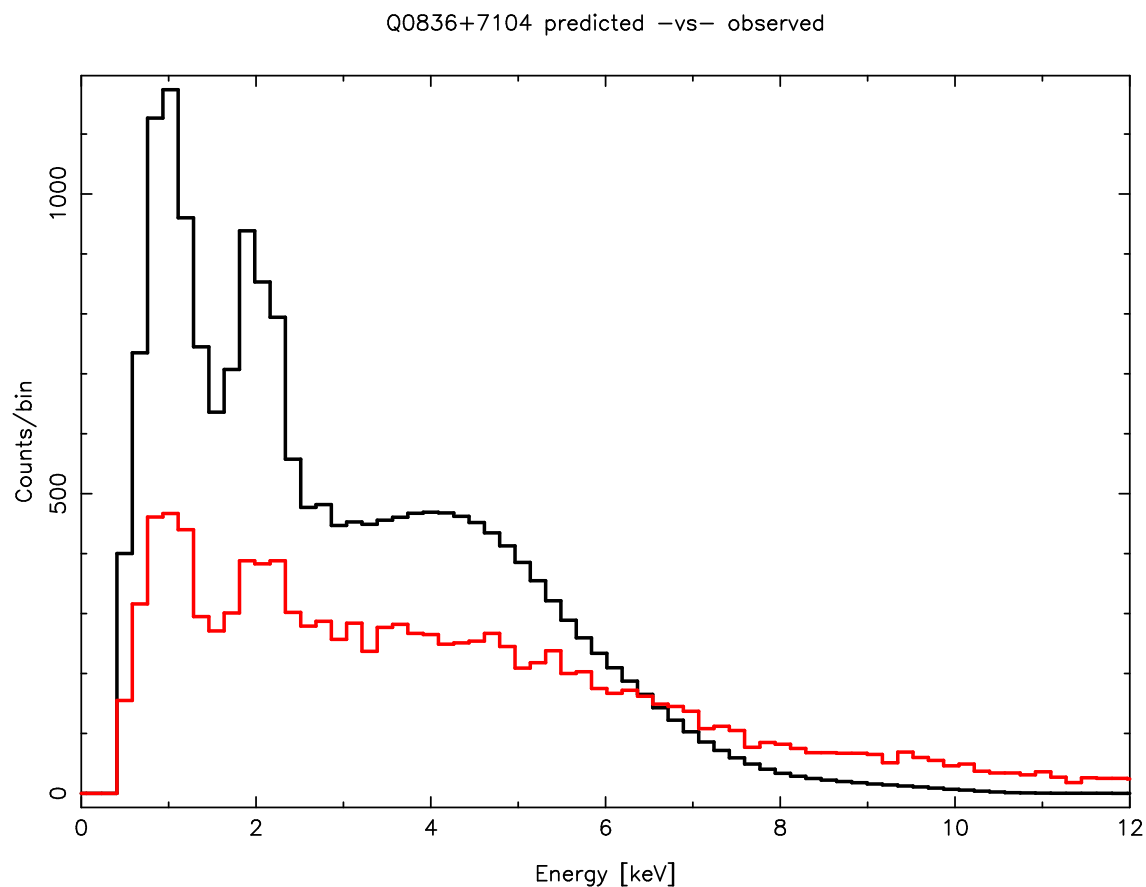



The charge cloud is not necessarily confined to a single pixel.

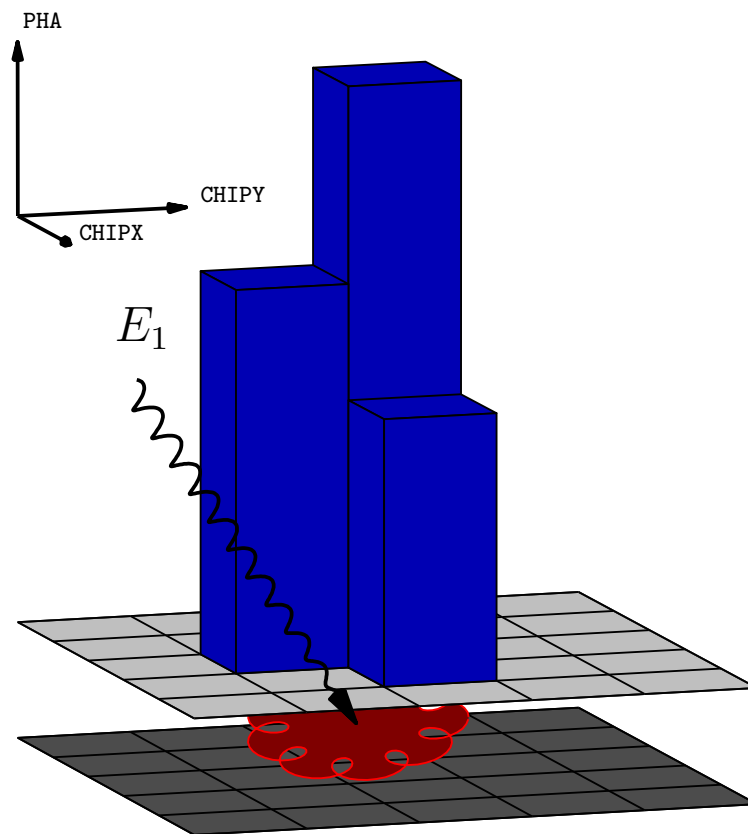



Cosmic rays also produce charge clouds!

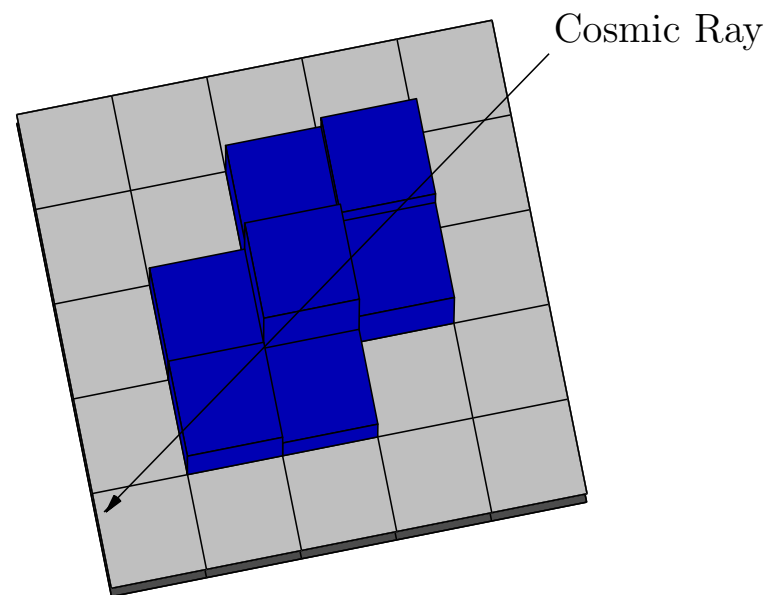
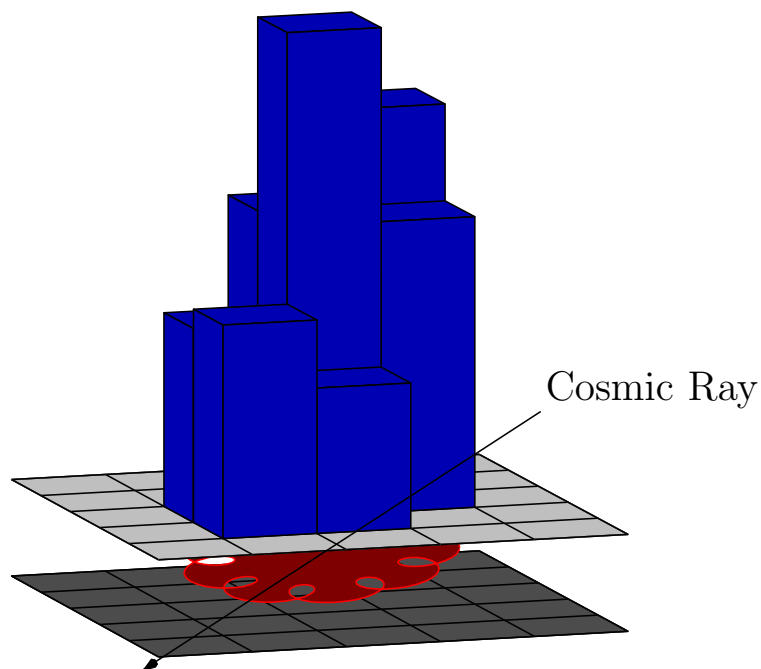

Fortunately, the charge cloud patterns, or “grades”, from cosmic rays are different from the patterns produced by X-rays.



X-rays are more likely to produce events with “good grades”.

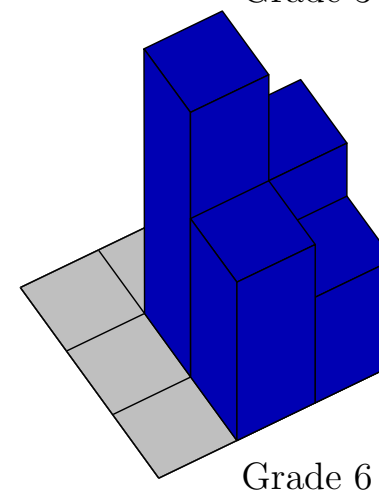
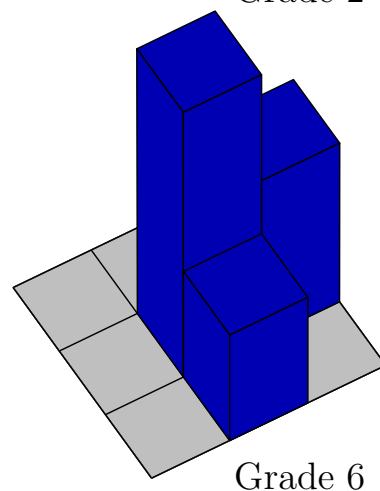
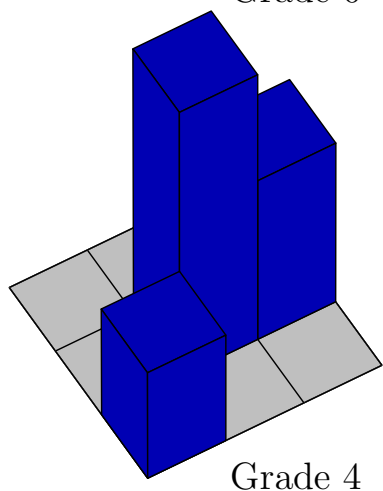
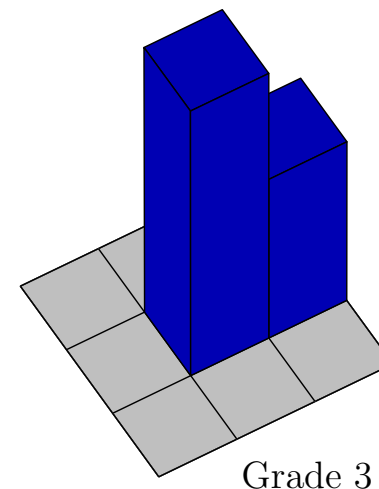
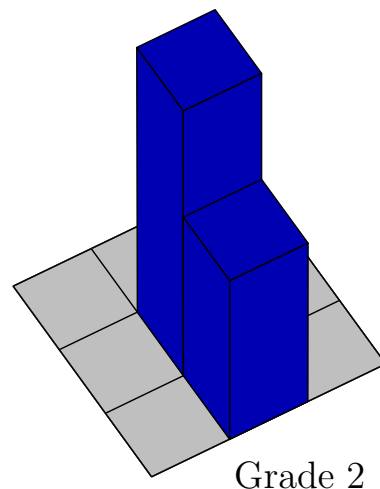
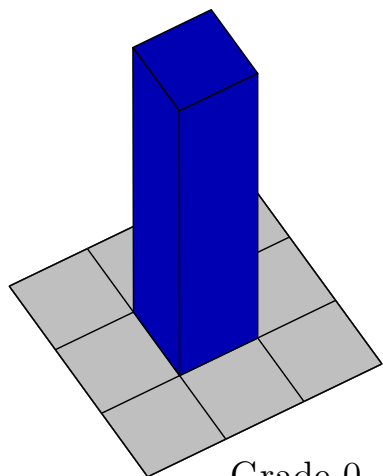



Cosmic rays are more likely to produce events with ‘bad grades’.

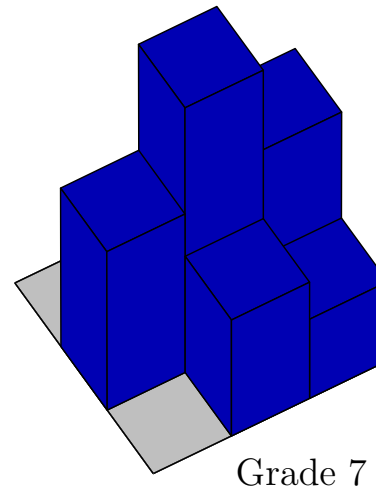
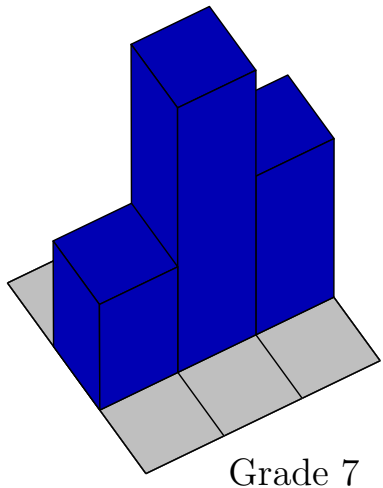
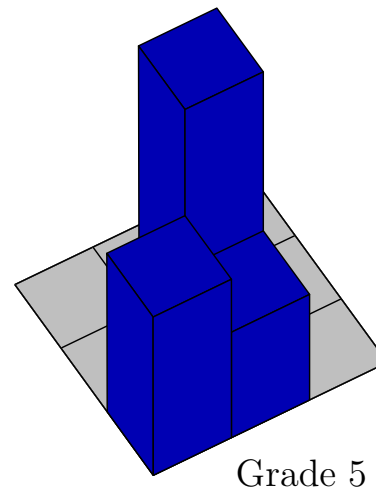
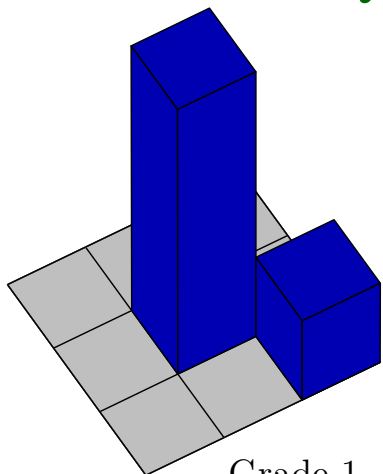



Pile-up can also produce events with ‘bad grades’.

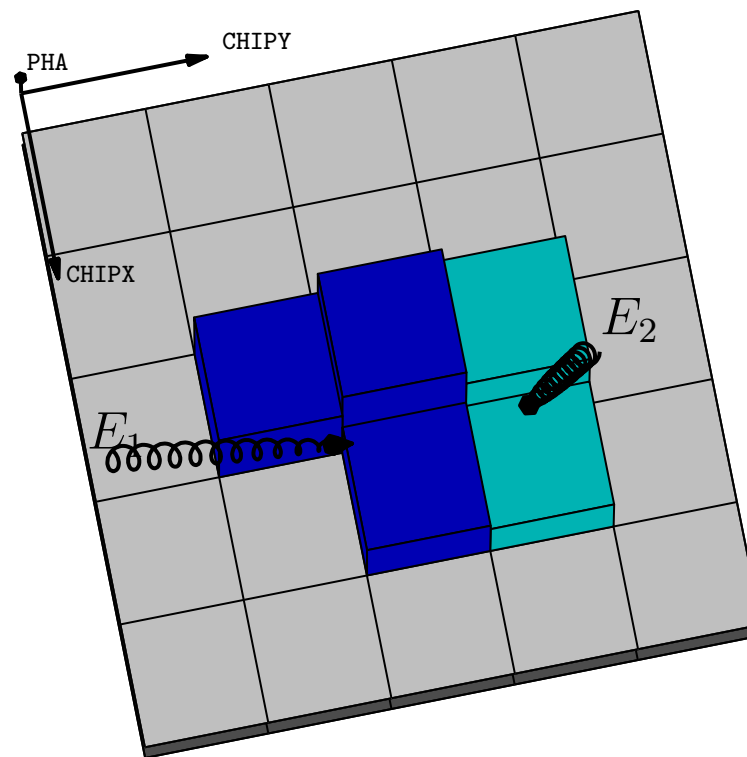
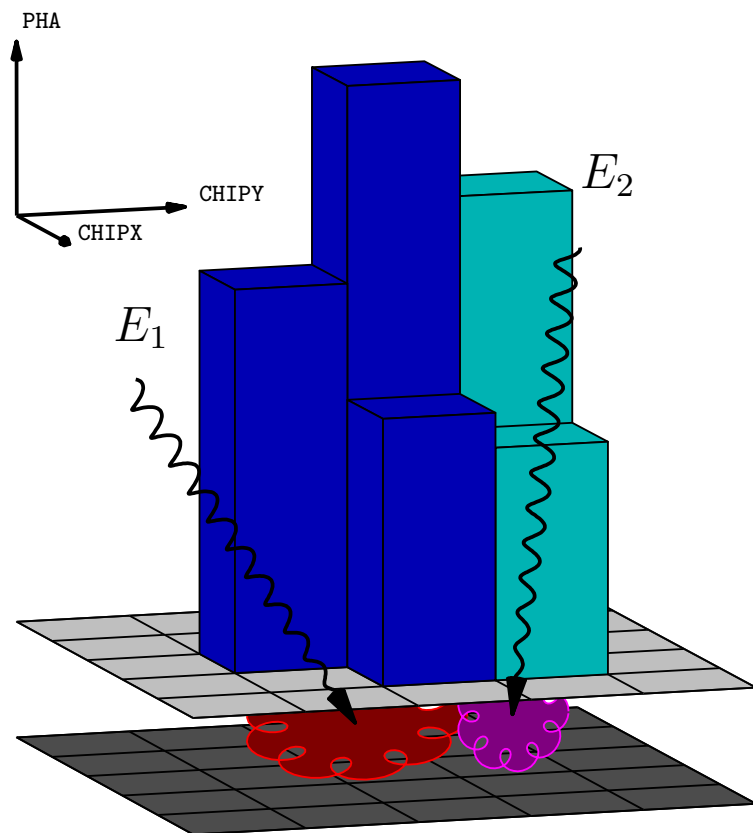

This effect is called ‘Grade Migration’.



The ‘Standard Model’

$$C(h) = (N\tau) \int dE R(h, E)A(E)s(E)$$

$C(h)$	The number of counts in pulse-height bin h .	<code>dmextract</code>
$s(E)$	Incident source flux	<code>sherpa</code>
$A(E)$	Effective area, or ‘ARF’	<code>mkarf</code>
$R(h, E)$	Detector redistribution matrix, or ‘RMF’	<code>mkrmf</code>
τ	CCD frame time	<code>≈ TIMEDEL</code>
N	Total number of CCD frames	<code>$N\tau = \text{EXPOSURE}$</code>



The Pile-up Model

$$C(h) = (N\tau)(1 - f) \int dE R(h, E)A(E)s(E) + Nne^{-(\tau/\bar{g}_0)} \int dE A(E)fs(E)/n \sum_{p=1}^{\infty} \alpha^{p-1} \int dE R(h, E) \frac{[\tau A(E)fs(E)/n]^{*p}}{p!}$$

- n The number of regions where pile-up occurs.
- f Total PSF fraction enclosed by the n pile-up regions.
- α Grade-migration survival probability.
- \bar{g}_0 Average branching ratio into “good” grades.
- $*p$ Convolution product ($\int \dots \int$)
 p



Data Preparation

Do not use pipeline-produced 2 files. They have so-called “afterglow” events removed. For a bright source, up to 20 percent of the events can be mistaken as afterglow events and removed from the level-2 files.

Use reprocessed level 1 files with CTI correction turned off. The CTI correction algorithm assumes that there will be at most one event per row during a frame.

Exercise care in creating lightcurves. The pile-up model assumes that photon arrival times are Poisson distributed. Use time-intervals where the incident flux is constant. Use either the counts in the wings of the PSF or in the readout streak.



II Peg Light Curve *OBSID 1451, HETG/ACIS-S, Claude Canizares*

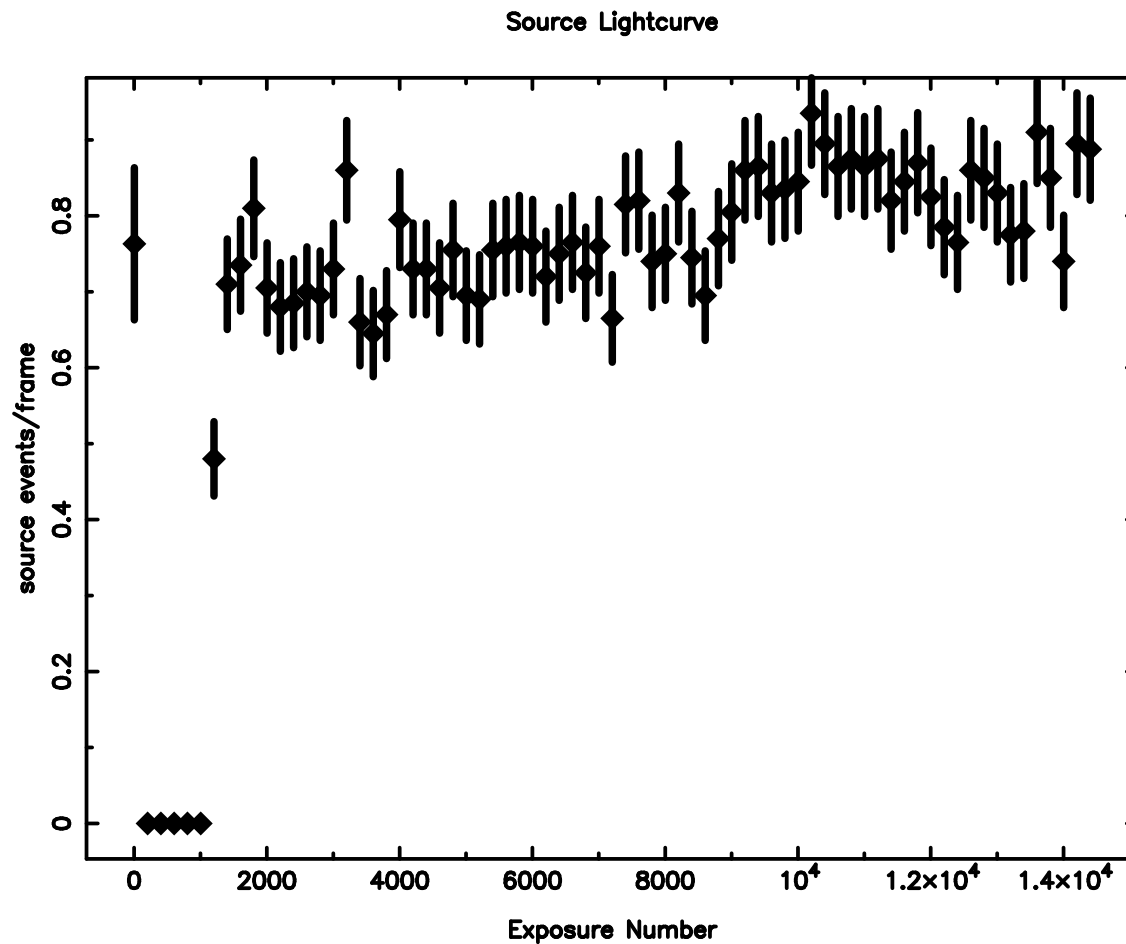



II Peg Light Curve

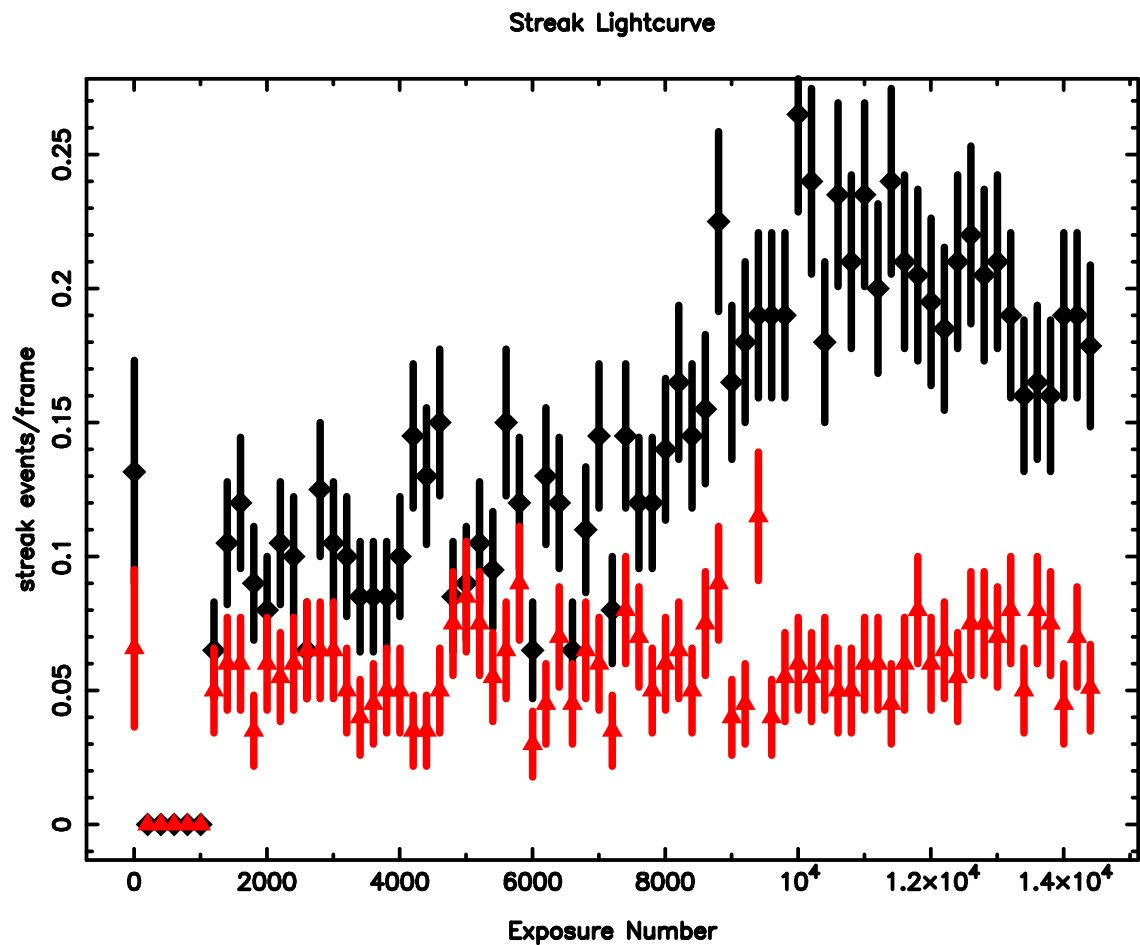



Use the right extraction region

For an on-axis point source, it is recommended that a circular region with a 2 arc-second radius be used (4 ACIS pixels). A larger region will decrease the signal to noise ratio.

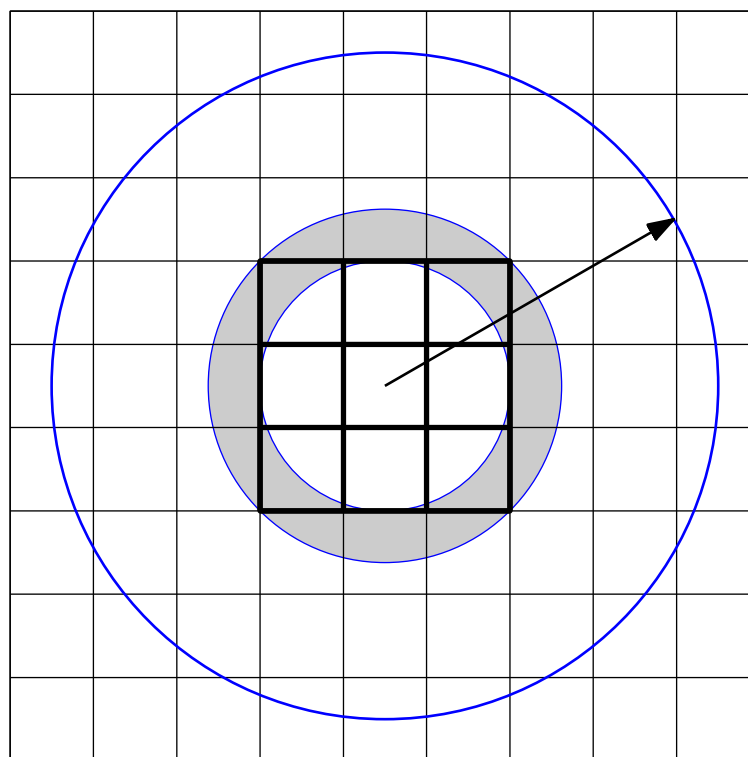



Using the pile-up model in sherpa

```
sherpa> jdpileup[jdp1]  
sherpa> pileup 1 = jdp1  
sherpa> jdp1.ftime = 3.2  
sherpa> jdp1.n = 1  
sherpa> jdp1.alpha = 0.5  
sherpa> jdp1.f = 0.95  
sherpa> thaw jdp1.f jdp1.alpha  
sherpa> fit  
sherpa> show pileup
```



Using the pile-up model in isis

```
.  
.   
isis> set_kernel (1, "pileup");  
isis> set_par ("pileup<1>.nregions", 1, 1);  
isis> set_par ("pileup<1>.alpha", 0.5, 0);  
isis> set_par ("pileup<1>.psffrac", 0.95, 0);  
isis> fit_counts;  
isis> print_kernel (1);
```



Example 1: Q0836+7104 *OBSID 1450, HETG/ACIS-S, Claude Canizares*

```
isis> fit_counts;
```

```
Parameters[Variable] = 7[5]  
Data bins = 67  
Chi-square = 63.1  
Reduced chi-square = 1.018
```

```
isis> list_par;
```

```
phabs(1)*powerlaw(1)
```

idx	param	tie-to	freeze	value	min	max
1	phabs(1).nH	0	0	0.03381944	0	0.2
2	powerlaw(1).norm	0	0	0.002399927	0	0.01
3	powerlaw(1).PhoIndex	0	0	1.374511	0	3
4	pileup<1>.nregions	0	1	1	1	10
5	pileup<1>.g0	0	1	1	0	1
6	pileup<1>.alpha	0	0	0.8728455	0.35	1
7	pileup<1>.psfrac	0	0	0.9304663	0.9	1



Spectral Fit

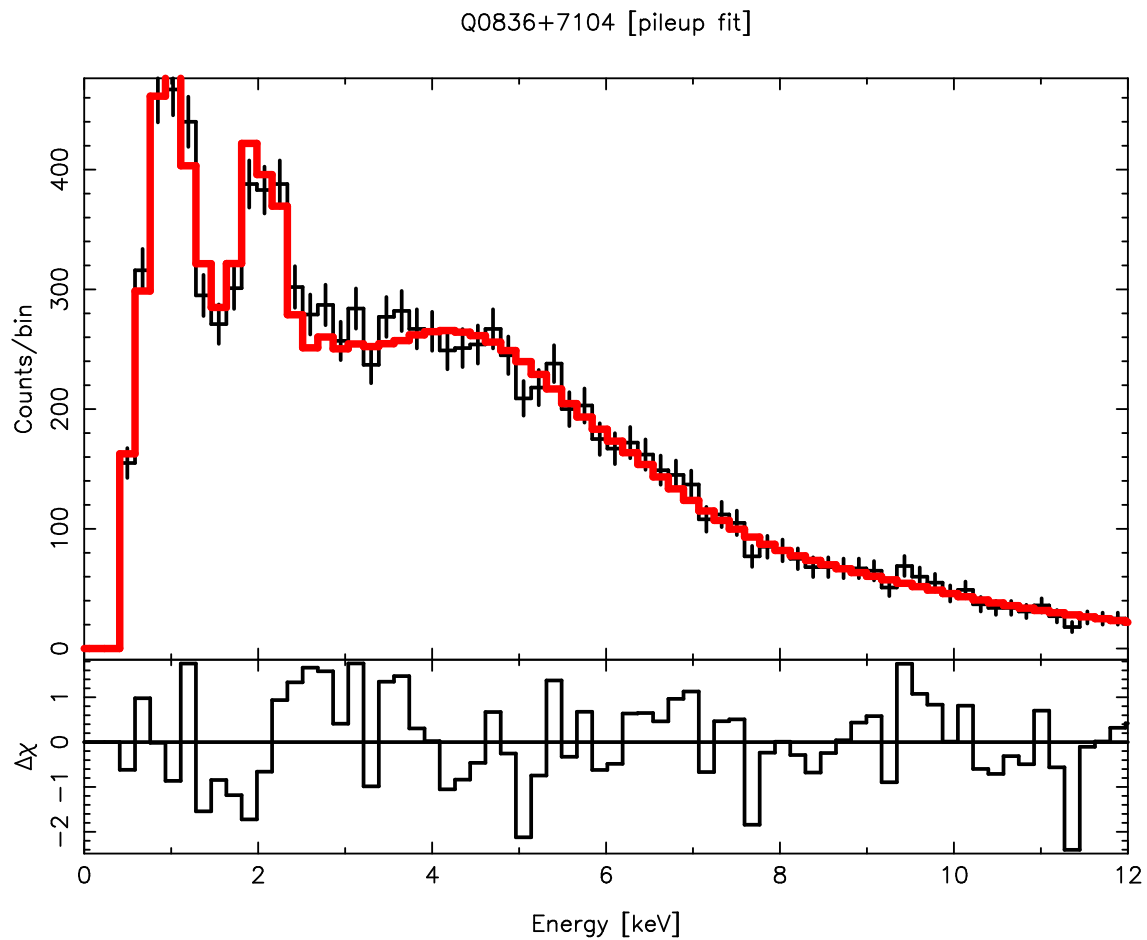



Pile-up Fraction

```
isis> print_kernel(1);  
1: 0.367879      0.625742  
2: 0.184252      0.273553  
3: 0.061522      0.0797253  
4: 0.0154067     0.0174266  
5: 0.00308658    0.00304732  
6: 0.000515305   0.000444061  
7: 7.37403e-05   5.54651e-05  
8: 9.23323e-06   6.06186e-06  
*** pileup fraction: 0.374258
```



Confidence Contours

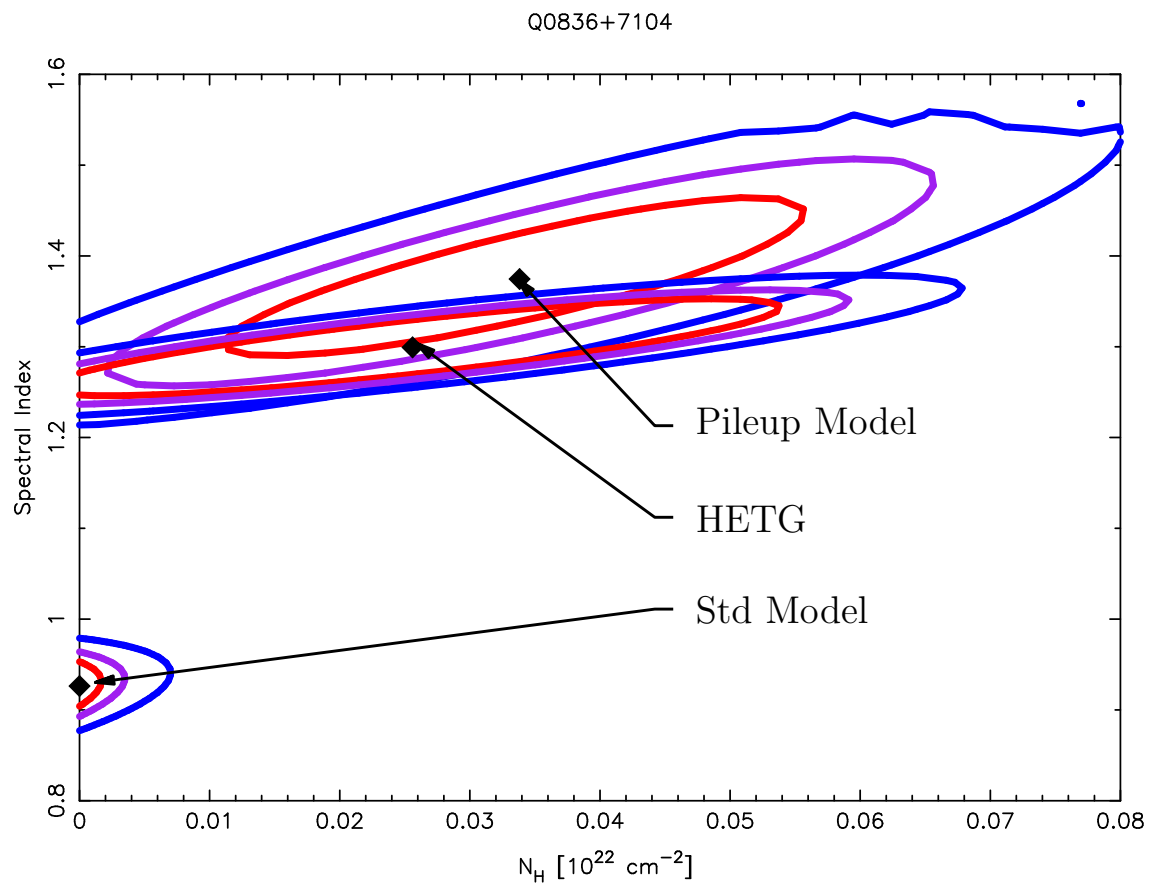



Example 2: NGC 4579 *OBSID 807, ACIS-S, Michael Eracleous*

```
isis> fit_counts;
```

```
Parameters[Variable] = 7[5]  
    Data bins = 82  
    Chi-square = 103.6  
    Reduced chi-square = 1.346
```

```
isis> list_par;
```

```
phabs(1)*powerlaw(1)
```

idx	param	tie-to	freeze	value	min	max
1	phabs(1).nH	0	0	0.02727911	0	0.2
2	powerlaw(1).norm	0	0	0.001469524	0	0.1
3	powerlaw(1).PhoIndex	0	0	1.764569	1	3
4	pileup<1>.nregions	0	1	1	1	10
5	pileup<1>.g0	0	1	1	0.8	1
6	pileup<1>.alpha	0	0	0.6937202	0	1
7	pileup<1>.psffrac	0	0	0.902147	0.8	1



Spectral Fit

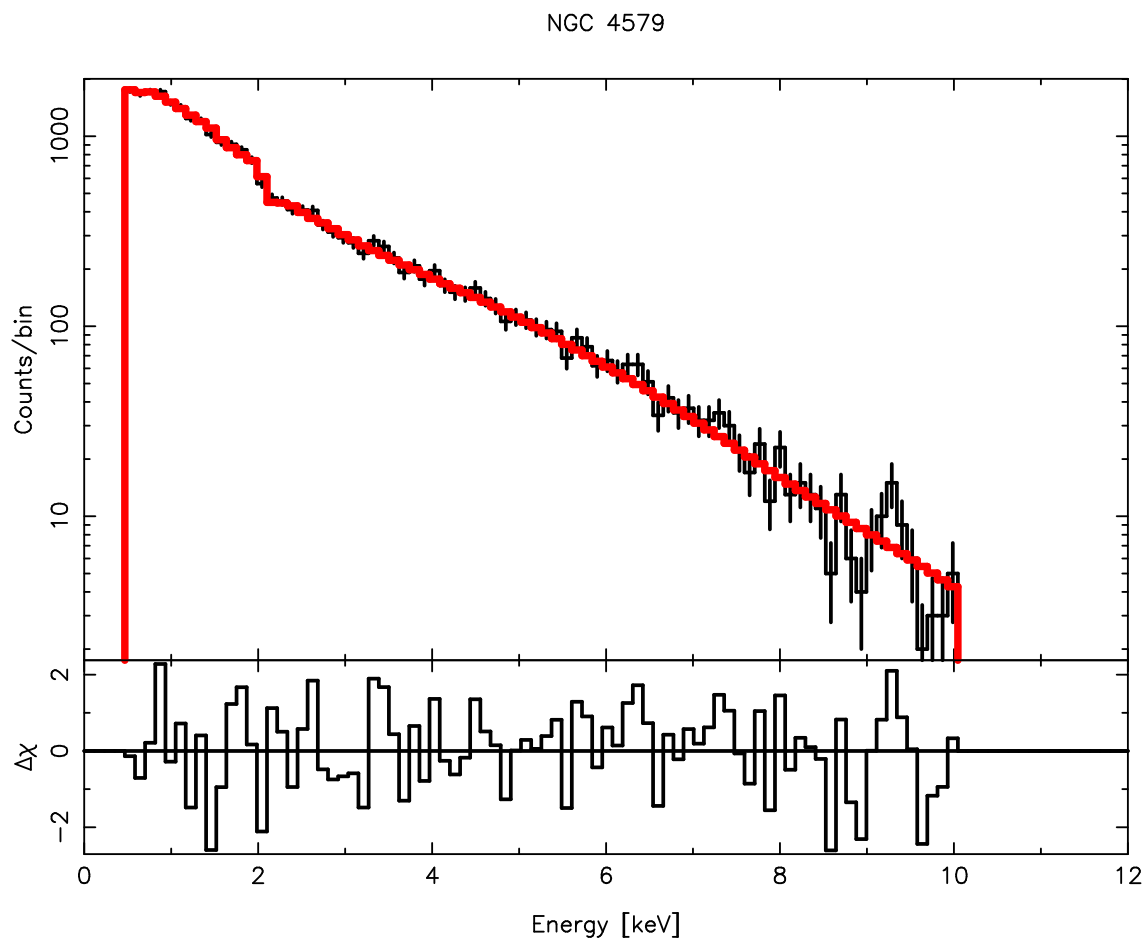



Pile-up Fraction

```
isis> print_kernel(1);
```

```
1: 0.367835      0.688744
2: 0.186795      0.242635
3: 0.0632391     0.0569848
4: 0.0160571     0.0100375
5: 0.00326167    0.00141443
6: 0.000552117   0.000166095
7: 8.01078e-05   1.67181e-05
8: 1.01701e-05   1.47239e-06
*** pileup fraction: 0.311256
```



Confidence Contours

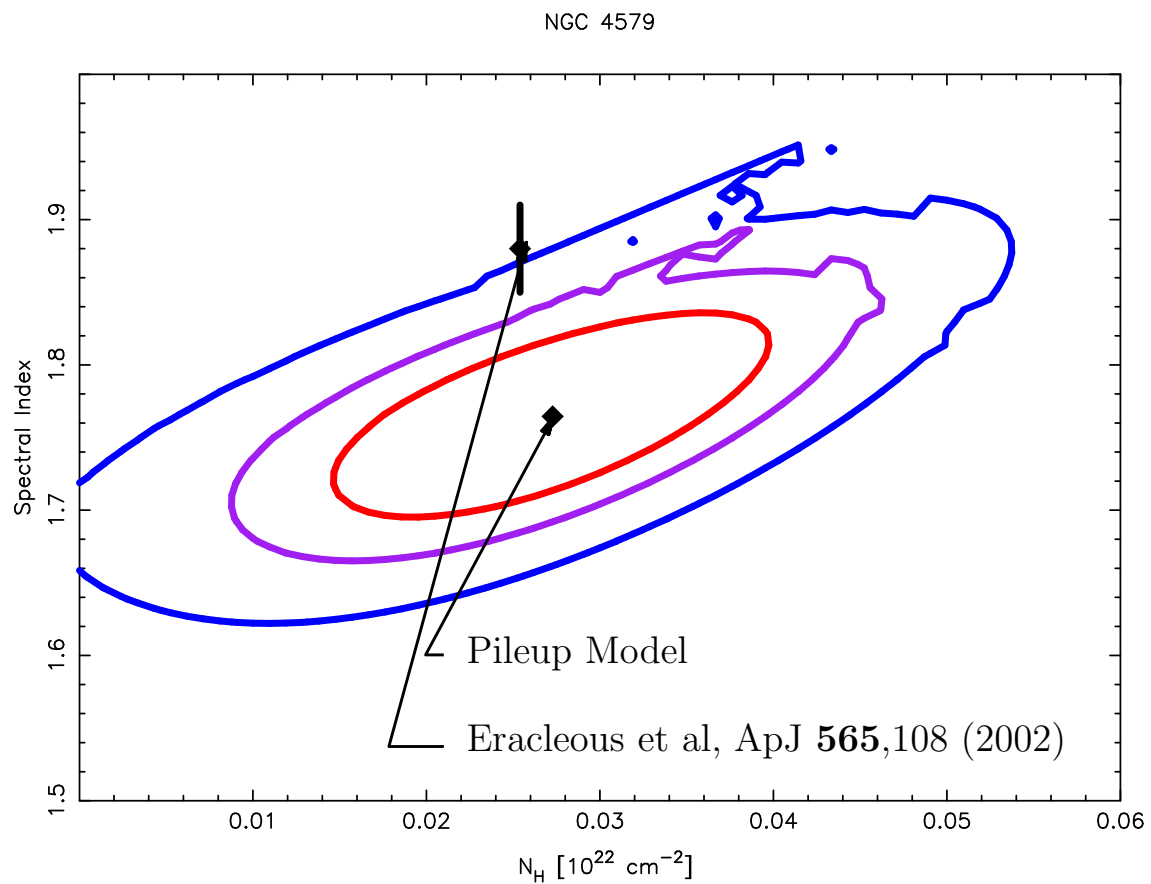



Example 3: Nucleus of M81 *OBSID 735, ACIS-S, Douglas Swartz*

```
isis> fit_counts;
```

```
Parameters[Variable] = 7[5]  
    Data bins = 99  
    Chi-square = 120.8  
    Reduced chi-square = 1.285
```

```
isis> list_par;
```

```
phabs(1)*powerlaw(1)
```

idx	param	tie-to	freeze	value	min	max
1	phabs(1).nH	0	0	0.08063485	0	1
2	powerlaw(1).norm	0	0	0.006880267	0	0.1
3	powerlaw(1).PhoIndex	0	0	1.92351	0	3
4	pileup<1>.nregions	0	1	3	1	10
5	pileup<1>.g0	0	1	1	0	1
6	pileup<1>.alpha	0	0	0.4810092	0	1
7	pileup<1>.psffrac	0	0	0.9578905	0	1



Spectral Fit

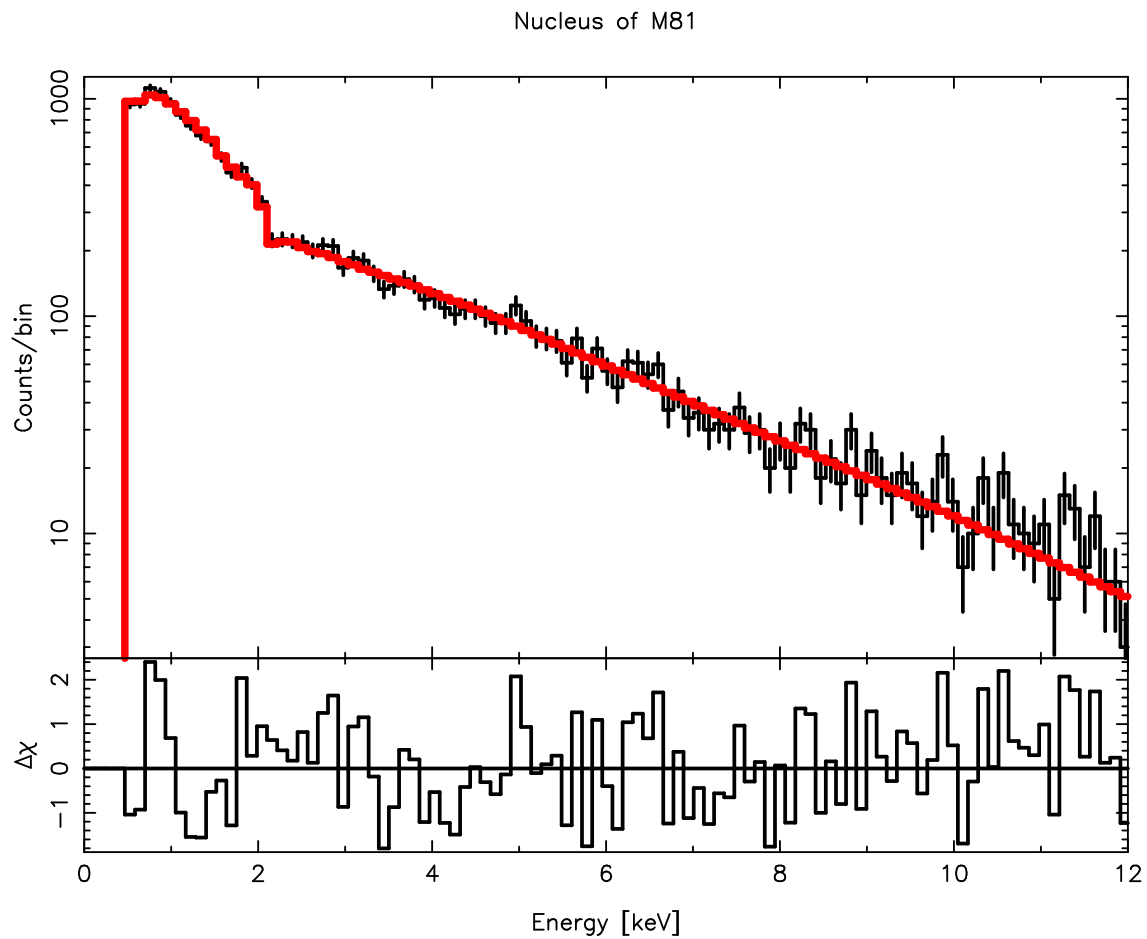



Pile-up Fraction

```
isis> print_kernel(1);
```

```
1: 0.0241037    0.207965
2: 0.0652543    0.270813
3: 0.117772     0.235102
4: 0.159419     0.153076
5: 0.172633     0.0797342
6: 0.155786     0.03461
7: 0.1205       0.0128769
8: 0.0815551    0.0041921
9: 0.0490641    0.0012131
10: 0.0265656   0.000315941
11: 0.0130762   7.48036e-05
12: 0.00590006  1.62349e-05
13: 0.00245736  1.04828e-05
*** pileup fraction: 0.792035
```



Confidence Contours

